

KENWOOD

DUAL SIZED CD/CASSETTE RECEIVER

DPX-410

INSTRUCTION MANUAL

KENWOOD CORPORATION



Take the time to read through this instruction manual. Familiarity with installation and operation procedures will help you obtain the best performance from your new CD/CASSETTE RECEIVER.







For your records

Record the serial number, found on the back of the unit, in the spaces designated on the warranty card, and in the space provided below.

Refer to the model and serial numbers whenever you call upon your KENWOOD dealer for information or service on the product.

Model DPX-410 Serial number _____

CONTENTS

●WARNING	3
●SAFETY PRECAUTIONS	5
●FEATURES OF DPX-410	8
●OPERATIONS	
ALL MODE	10
 TUNER MODE	14
 TAPE MODE	18
 CD MODE	24
 DISC CHANGER CONTROL MODE	28
 OTHER MODE	34
 REMOTE CONTROL MODE	38
CONNECTIONS	42
ACCESSORIES FOR INSTALLATIONS	44
REPLACING THE FUSE	44
INSTALLATIONS	45
TROUBLESHOOTING GUIDE	50
SPECIFICATIONS	54

The display illustrations appearing in this manual were created to augment the explanations. These illustrations may differ from the actual displays.

⚠ WARNING



Dear Customer:

Selecting fine audio equipment such as the unit you've just purchased is only the start of your musical enjoyment. Now it's time to consider how you can maximize the fun and excitement your equipment offers. This manufacturer and the Electronic Industries Association's Consumer Electronics Group want you to get the most out of your equipment by playing it at a safe level. One that lets the sound come through loud and clear without annoying blaring or distortion — and, most importantly, without affecting your sensitive hearing.

Sound can be deceiving. Over time your hearing "comfort level" adapts to higher volumes of sound. So what sounds "normal" can actually be loud and harmful to your hearing. Guard against this by setting your equipment at a safe level **BEFORE** your hearing adapts.

To establish a safe level:

- Start your volume control at a low setting.
- Slowly increase the sound until you can hear it comfortably and clearly, and without distortion.

Once you have established a comfortable sound level:

- Set the dial and leave it there.

Taking a minute to do this now will help to prevent hearing damage or loss in the future. After all, we want you listening for a lifetime.

We Want You Listening For A Lifetime

Used wisely, your new sound equipment will provide a lifetime of fun and enjoyment. Since hearing damage from loud noise is often undetectable until it is too late, this manufacturer and the Electronic Industries Association's Consumer Electronics Group recommend you avoid prolonged exposure to excessive noise. This list of sound levels is included for your protection.

Decible

Level Example

30	Quiet library, soft whispers
40	Living room, refrigerator, bedroom away from traffic
50	Light traffic, normal conversation, quiet office
60	Air conditioner at 20 feet, sewing machine
70	Vacuum cleaner, hair dryer, noisy restaurant
80	Average city traffic, garbage disposals, alarm clock at two feet.

THE FOLLOWING NOISES CAN BE DANGEROUS UNDER CONSTANT EXPOSURE

90	Subway, motorcycle, truck traffic, lawn mower
100	Garbage truck, chain saw, pneumatic drill
120	Rock band concert in front of speakers, thunderclap
140	Gunshot blast, jet plane
180	Rocket launching pad

Information courtesy of the Deafness Research Foundation.

WARNING

CAUTION

Use of controls or adjustments or performance of procedures other than those specified herein may result in hazardous radiation exposure.

In compliance with Federal Regulations, following are reproductions of labels on, or inside the product relating to laser product safety.

KENWOOD CORPORATION
2967-3, ISHIKAWA-CHO,
HACHIOJI-SHI
TOKYO, JAPAN

KENWOOD CORP. CERTIFIES THIS EQUIPMENT
CONFORMS TO DHHS REGULATIONS NO.21 CFR
1040. 10, CHAPTER I, SUBCHAPTER J.

Location : Bottom Panel

FCC WARNING

This equipment may generate or use radio frequency energy. Changes or modifications to this equipment may cause harmful interference unless the modifications are expressly approved in the instruction manual. The user could lose the authority to operate this equipment if an unauthorized change or modification is made.

NOTE

This equipment has been tested and found to comply with the limits for a Class B digital device, pursuant to Part 15 of the FCC Rules. These limits are designed to provide reasonable protection against harmful interference in a residential installation. This equipment may cause harmful interference to radio communications, if it is not installed and used in accordance with the instructions. However, there is no guarantee that interference will not occur in a particular installation. If this equipment does cause harmful interference to radio or television reception, which can be determined by turning the equipment off and on, the user is encouraged to try to correct the interference by one or more of the following measures:

- Reorient or relocate the receiving antenna.
- Increase the separation between the equipment and receiver.
- Connect the equipment into an outlet on a circuit different from that to which the receiver is connected.
- Consult the dealer or an experienced radio/TV technician for help.

NOTE

This Class B digital apparatus meets all requirements of the Canadian interference-Causing Equipment Regulations.

SAFETY PRECAUTIONS

▲WARNING

To prevent injury and/or fire, take the following precautions:

- Insert the unit all the way until it is fully locked in place. Otherwise it may fly out of place during collisions and other jolts.
- When extending the ignition, battery or ground cables, make sure to use automotive-grade cables or other cables with an area of 0.75mm² (AVG 18) or more to prevent cable deterioration and damage to the cable coating.
- To prevent short circuits, never put or leave any metallic objects (e.g., coins or metal tools) inside the unit.
- If the unit starts to emit smoke or strange smells, turn off the power immediately and consult your Kenwood dealer.
- Be careful not to drop the unit or subject it to strong shock.

The unit may break or crack because it contains glass parts.

▲CAUTION

To prevent damage to the machine, take the following precautions:

- Make sure to ground the unit to a negative 12V DC power supply.
- Do not open the top or bottom covers of the unit.
- Do not install the unit in a spot exposed to direct sunlight or excessive heat or humidity. Also avoid places with too much dust or the possibility of water splashing.
- When replacing a fuse, only use a new one with the prescribed rating. Using a fuse with the wrong rating may cause your unit to malfunction.
- To prevent short circuits when replacing a fuse, first disconnect the wiring harness.
- During installation, do not use any screws except for the ones provided. The use of improper screws might result in damage to the main unit.

IMPORTANT INFORMATION

You cannot connect the unit directly to the following CD automatic changers. For users who want to use older changers with the unit, follow the directions below according to the type of changer you own:

• KDC-C200 / KDC-C300 / KDC-C400

Use the extension cable and the control box attached to the CD changer, and the optional CA-DS100 converter cord.

• KDC-C301 / KDC-C600 / KDC-C800 / KDC-C601 / KDC-C401

Use the extension cable attached to the CD changer, and the optional CA-DS100 converter cord.

• KDC-C100 / KDC-C302 / C205 / C705 / non-Kenwood CD changers

Cannot be used with this model.

▲CAUTION

You can damage both your unit and the CD changer if you connect them incorrectly.

- Using the KCA-S200 CD/MD Changer Switching Unit or KDC-C810 Disc Auto Changer with Disc Changer Select Function allows you to control two disc changers. For a detailed description of connections, please refer to the instruction manual supplied with each of these units.
- Functions which can be used may differ depending on the model being connected.

SAFETY PRECAUTIONS

NOTE

- If you experience problems during installation, consult your Kenwood dealer.
- If the unit does not seem to be working right, try pressing the reset button first. If that does not solve the problem, consult your Kenwood dealer.

Cleaning the Unit

If the front panel gets dirty, turn off the power and wipe the panel with a dry silicon cloth or soft cloth.

CAUTION

Do not wipe the panel with a stiff cloth or a cloth dampened by volatile solvents such as paint thinner and alcohol. They can scratch the surface of the panel and/or cause the indicator letters to peel off.

Cleaning the Tape Head

After you have used the tape player many times over a long period, magnetic powder from the tapes and dust accumulates on the tape head, causing noise and a deterioration in sound quality. Clean the tape head using a cleaning tape or cleaning kit designed for use in car audio systems.

Handling Cassette Tapes

- Do not play a cassette whose tape has gone slack. In such a case, wind it tight using a pencil or the like in one of the spools. Playing slack cassette tapes can result in the tape tangling around the capstan and/or pinch rollers, causing trouble.
- Do not play a deformed cassette or one whose label is starting to come off, as it can cause the unit to malfunction.
- Do not leave tapes in hot places, such as above the fascia panel (dashboard) and other spots exposed to direct sunlight, or near heater outlets. They can deform the cassette.
- Avoid using extremely long cassette tapes, such as 100-minute-long tapes. Such tapes are very thin, and can tangle easily around the pinch rollers or other parts inside the unit, causing unit failure.
- Remove a cassette tape from the unit when not listening to it for a while. If you leave a tape in the unit too long, it may stick to the tape head and cause unit malfunction.

Cleaning the CD Slot

As dust can accumulate in the CD slot, clean it occasionally. Your CDs can get scratched if you put them in a dusty CD slot.

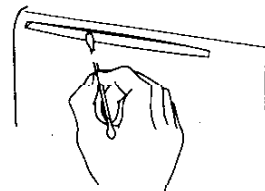

Lens Fogging

Right after you turn on the car heater in cold weather, dew or condensation may form on the lens in the CD player of the unit. Called lens fogging, CDs may be impossible to play. In such a situation, remove the disc and wait for the condensation to evaporate. If the unit still does not operate normally after a while, consult your Kenwood dealer.

Card Remote Control Battery

Insert the battery according to the following procedure before using the card remote control. Use a pen or another pointed item to release the lock in direction ① while pulling out the battery carrier in direction ②. Insert the supplied lithium battery (CR2025) correctly according to the ⊕ and ⊖ polarity markings on the battery carrier. When the battery is dead, replace it with a new one using the same procedure.

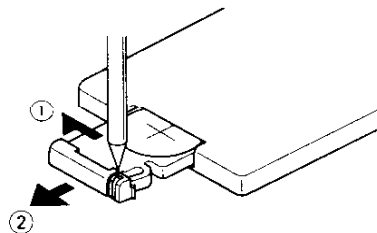

WARNING

Be sure to store the button-type lithium batteries outside the reach of small children. If accidentally swallowed, seek medical assistance immediately.

CAUTION

Do not set the remote control on hot places such as above the dashboard.

Playing a CD that is dirty, scratched or warped can cause the sound to skip and the unit to operate incorrectly, resulting in worsened sound quality. Take the following precautions to prevent your CDs from getting scratched or damaged.

Handling CDs

- Do not touch the recorded side of the CD (the side opposite the label) when holding it.

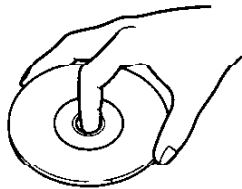

- Do not stick tape on either side of the CD.

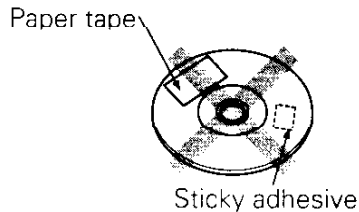

Storing CDs

- Do not store CDs in areas exposed to direct sunlight – such as a car seat or above the fascia panel (dashboard) – or other hot places.
- Remove CDs from the unit when not listening to them for a while, and put them back in their cases. Do not stack CDs that have been removed from their cases or prop them against something.

Cleaning CDs

If a CD has become dirty, wipe it off gently using a commercially available cleaning cloth or a soft cotton cloth, starting from the center of the disc and moving outward. Do not clean CDs with conventional record cleaners, anti-static formulas, or chemicals such as paint thinner or benzene.

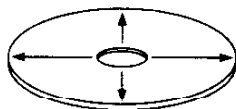

Checking New CDs for Burrs

When playing a new CD for the first time, check that there are not any burrs stuck to the perimeter of the disc or in the central hole. CDs with burrs stuck on them may not load properly or may skip while playing. Remove burrs using a ballpoint pen or a similar utensil.

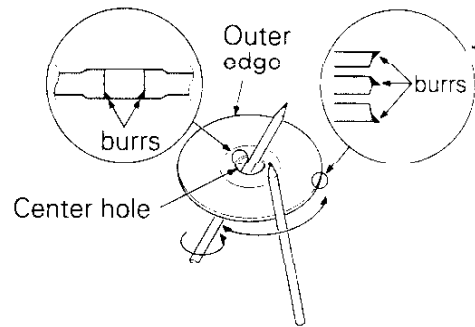

Do Not Load CD Accessories in Slot

Do not use commercially available CD accessories that can be loaded into the CD slot, such as stabilisers, protective sheets, or CD cleaning discs, since they can cause the unit to malfunction.

Do Not Use Special Shape CDs

Be sure to use round shape CDs only for this unit and do not use any special shape CDs. Use of special shape CDs may cause the unit to malfunction.

Removing the CD

Only remove the CD from the machine in a horizontal direction. You may damage the surface of the CD if you try pulling it down as it ejects.

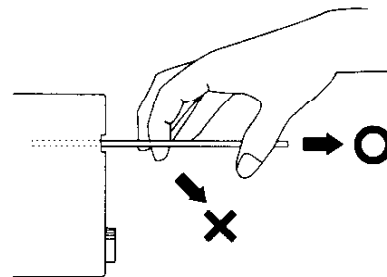

FEATURES OF DPX-410

DNPS / SNPS

Disc Name Preset / Station Name Preset

Disc Name Preset

This feature allows you to store the names of CDs for CD player and discs for optional disc changers to be displayed when played.

- The number of disc changer discs for which a name can be associated differs according to the model of the disc changer.
- DNPS is not to be used to store the disc and track titles for MDs.
- You can only store names for CD player up to 10 CDs.

Station Name Preset

Station names can be associated with the frequencies of a total of 30 FM and AM stations. By presetting the station name to frequently listened to stations, the station name can be displayed instead of the frequency.

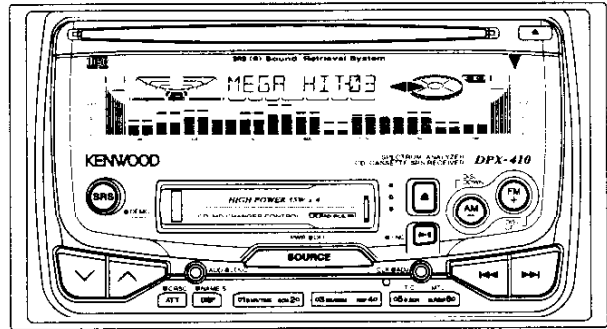

DNPP / SNPP

Disc Name Preset Play / Station Name Preset Play

Disc Name Preset Play

This function displays in order the discs to which names have been associated with Disc Name Preset and permits disc selection by name.

Station Name Preset Play

This function displays in tuner memory order the stations to which names have been associated with Station Name Preset and permits selection of station by name.

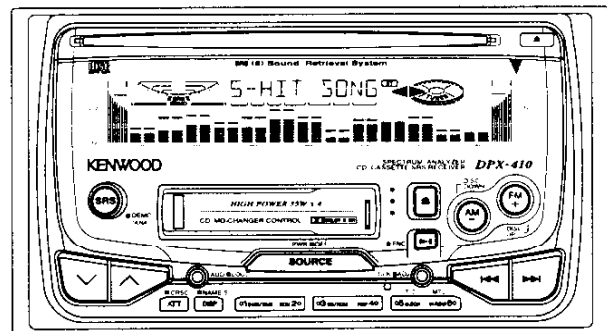

SRS

Sound Retrieval System

○ Sound Retrieval System

Even in the acoustically unfavorable small space inside a car, this system can reproduce an atmosphere imbued with the presence of a concert hall, live venue, or some other effect.

With this system even inside a car, it is now possible to enjoy excellent sound reproduction. By adjusting the CENTER and SPACE parameters of the audio signal, it is possible to set the spatial atmosphere to one of 3 levels.

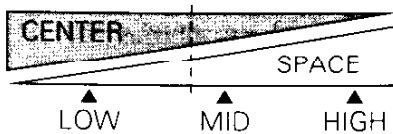
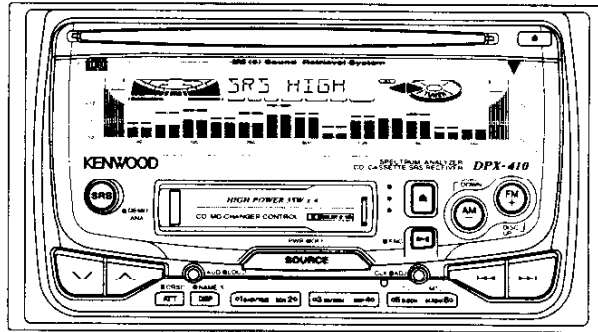

Sound Retrieval System manufactured under licence from SRS Labs, Inc. "SOUND RETRIEVAL SYSTEM" and the SRS Symbol (●) are trademarks of SRS Labs, Inc. USP NO. 4748669

FUNCTION SET MODE

○ Function Set Mode

The function set mode system used in this unit permits a greater number of functions to be included as well as simplification of the design.

- The four functions listed below are the ones which are set using the function set mode.
- Details on each setting are explained separately in the corresponding function page.

Function name	Function page
Touch Tone Sensor ON/OFF	P.12
Preout Selection	P.12
Auto Memory	P.15
Side Bar Display Select	P.36

ALL MODE

ALL MODE

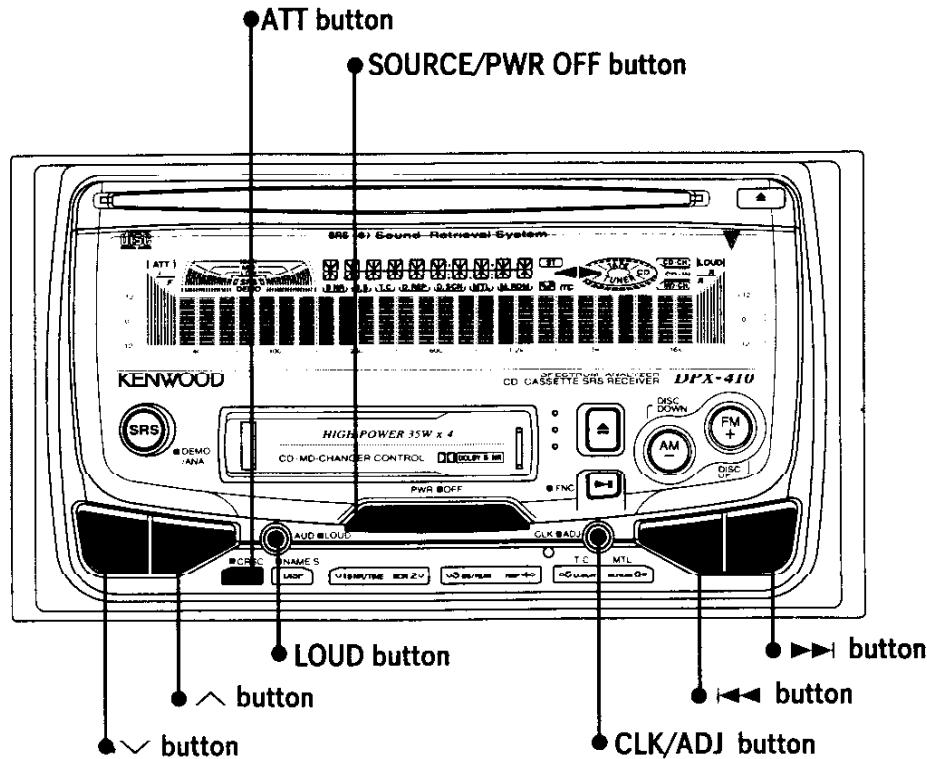

1

Power On - Turning on the power -

Press the SOURCE button to turn the power on.

NOTE

The unit will come on in the mode it was in the last time power was turned off.

2

Power Off - Turning off the power -

Press the PWR OFF button for more than one second to turn the power off.

3

Volume - Adjusting the volume -

The volume level will go up each time the ^ button is pressed.
The volume level will go down each time the v button is pressed.

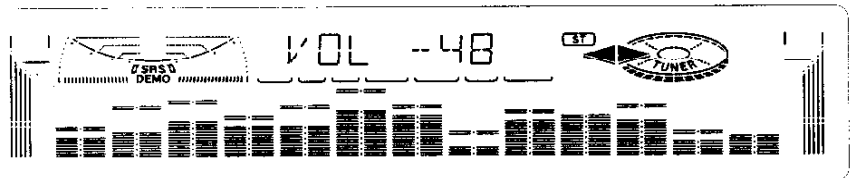

4

Attenuator - Turning down the volume quickly -

Attenuator is switched on and off each time the ATT button is pressed.
The ATT indicator will blink while the attenuator is on and the volume will be lowered instantaneously.

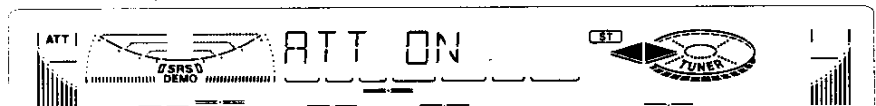

5

Loudness – Modulating the sound for effect when the volume is low –

Loudness is switched on and off each time the LOUD button is pressed. While this function is on, the LOUD indicator will light and highs and lows will be emphasized.

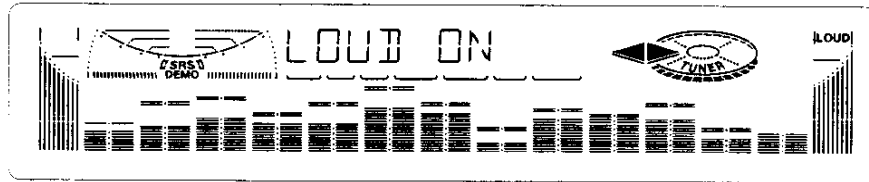

NOTE

Only lows is emphasized during tuner mode.

6

Source Mode Select – Selecting a source to listen to –

Each time the SOURCE button is pressed, the source mode will be switched in the order given below:

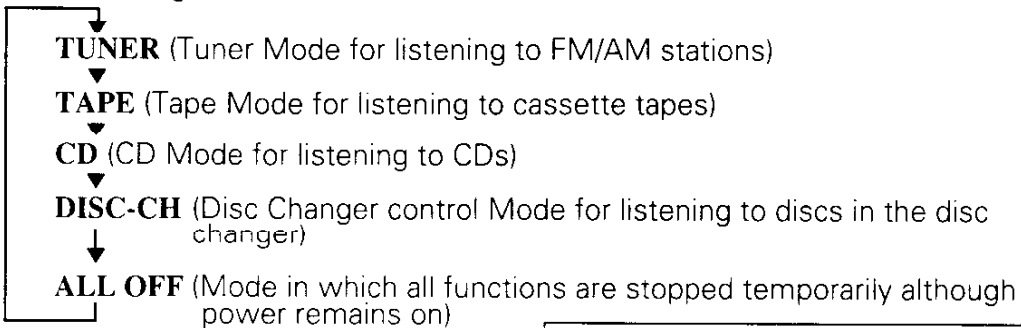

You can check the display to find the mode currently selected.



NOTE

- You cannot select the associated mode when there is no cassette tape loaded, CD inserted, or disc changer connected.
- If there are two disc changers connected, disc changer control mode selection first selects DISC-CH1 then DISC-CH2.

7

Clock display – Switching to the clock display –

Each press of the CLK button toggles the display between the current source mode display and the clock display.

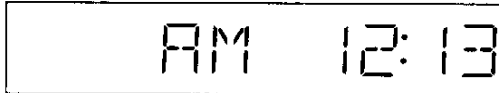

NOTE

The clock will not be displayed when the power of this unit is off nor when the vehicle engine key is off.

8

Clock Adjustment – Setting the clock –

1. Bring up the clock display by pressing the CLK button.
2. Adjust the hour by pressing the ◀◀ button while holding down the ADJ button and adjust the minute by pressing the ▶▶ button while holding down the ADJ button.

ALL MODE

ALL MODE

ALL MODE

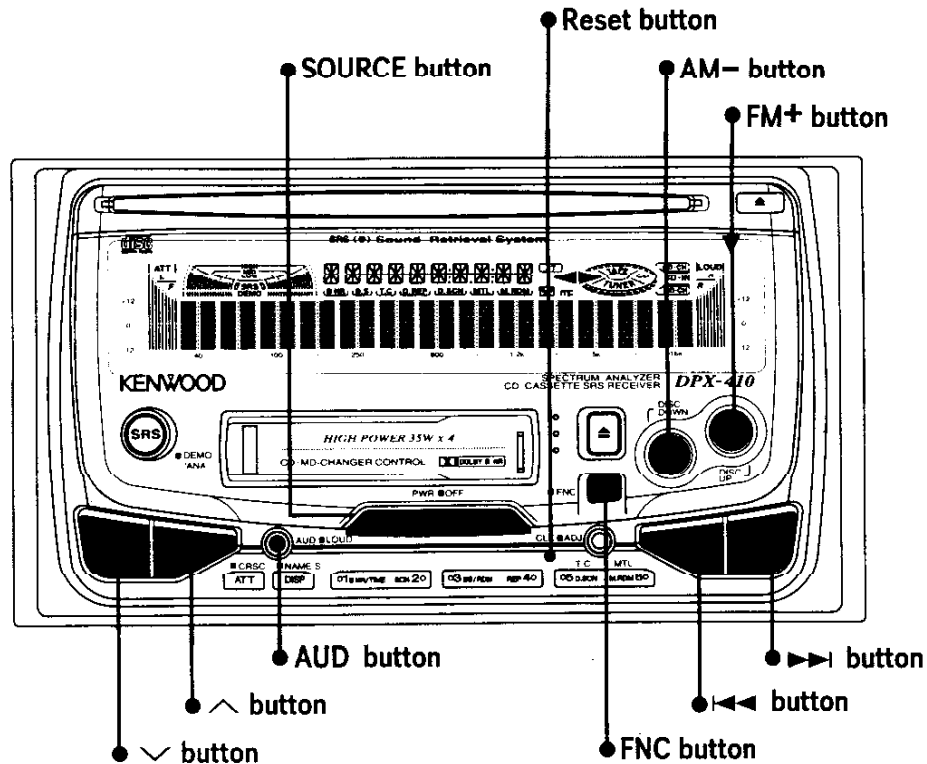

9

Touch Tone Sensor On/Off – Turning the beeping sound on/off –

1. Press the SOURCE button, which will display "ALL OFF".
2. Press the FNC button for 1 second or longer.
"FNC ON" will be displayed and the function set mode enabled.
3. Press the ◀◀ or ▶▶ button to set the touch tone sensor on/off switching mode.
The touch tone sensor on/off switching mode is indicated by the following two types of display depending on the current settings.
"BEEP ON".....Touch tone sensor on (Initial setting)
"BEEP OFF".....Touch tone sensor off
4. Press the FM+ button to switch on the touch tone sensor or press the AM- button to switch off the touch tone sensor.
5. Press the FNC button to exit the function set mode.

10

Preout Selection – Switching the rear preout to subwoofer output –

1. Press the SOURCE button, which will display "ALL OFF".
2. Press the FNC button for 1 second or longer.
"FNC ON" will be displayed and the function set mode enabled.
3. Press the ◀◀ or ▶▶ button to set the preout selection mode.
The preout selection mode is indicated by the following two types of display depending on the current settings.
"REAR" Rear output (Initial setting)
"NON-FADER" Non-fading output

4. Press the FM+ button to select the non-fading output or press the AM- button to select the rear output.
5. Press the FNC button to exit the function set mode.

NOTE

Non fading means that the volume level of output does not change regardless of the front/rear balance adjustment using Fader. This is mainly used when connecting a subwoofer power amp.

11

Audio Control – Adjusting each source of audio –

1. Press the AUD button to enter the audio adjustment mode.
2. Each time the AUD button is pressed, the adjustment mode will be switched in the order given below.
3. A press of the ^ or v button in any mode permits a change of the setting.

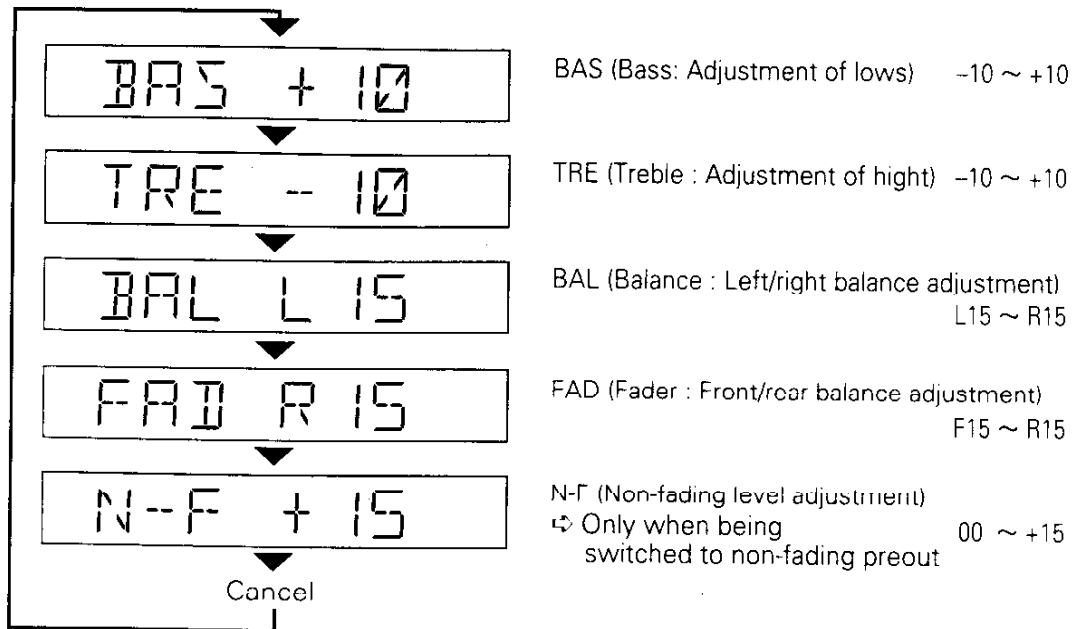

NOTE

- If no buttons are pressed for more than 5 seconds, the audio adjustment mode is automatically canceled.
- The non-fading level adjusts with the volume difference between the non-fading output and the rear output/front-rear speaker output. The volume is adjusted the lowering the volume of the rear output/front-rear speaker output without changing the volume of the non-fading output.
- Each source (FM, AM, Tape, CD, Disc changer) has its own memory in which to store the bass and treble tone settings. The settings made for a particular source are recalled automatically whenever you use that source.

12

System Reset

Use the tip of a pen or some other item to press the reset button at such times as a malfunction of the disc changer, when a fault occurs with the unit, or when the battery has been replaced.

NOTE

All memory contents except for station/disc names will be erased upon system reset.

TUNER MODE

TUNER MODE

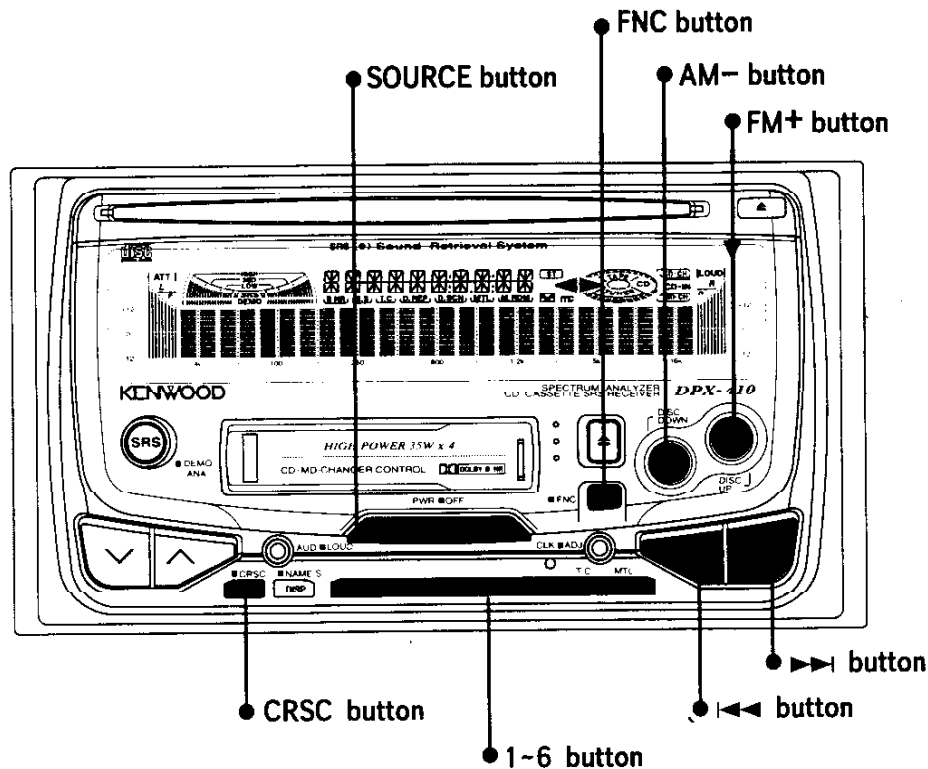

Tuning - listening to FM / AM broadcasting -

1. Select "TUNER" in the display by pressing the SOURCE button.
2. Press either the FM+ or AM- button to select the band.
The unit will switch between "F1", "F2" and "F3" in the FM band each time the FM+ button is pressed.
The unit will switch to "AM" in the AM band when the AM- button is pressed.
The band selected will be displayed.
3. ● **Selecting a station by manual tuning**
Each time the ◀◀ button is pressed, the unit will tune one step at a time toward lower frequencies.
Each time the ▶▶ button is pressed, the unit will tune one step at a time toward higher frequencies.
● **Selecting a station by auto tuning**
Pressing the ◀◀ button for more than 0.5 seconds will cause the unit to automatically search for and begin receiving the next station toward lower frequencies.
Pressing the ▶▶ button for more than 0.5 seconds will cause the unit to automatically search for and begin receiving the next station toward higher frequencies.

The ST indicator will light while receiving stereo broadcasts.

NOTE

Only monaural reception is available for the AM.

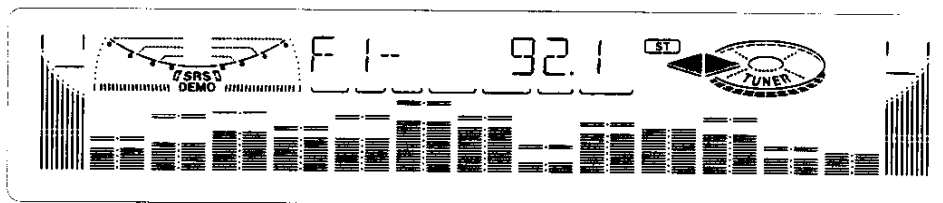

TUNER MODE

2

Tuner Memory – Setting the current station in memory –

● **Storing the frequency of a station**

Pressing any number button 1 through 6 for more than 2 seconds while receiving a station will cause the station currently being listened to be set in memory in the button pressed.

The button No. will be displayed at this time. Up to six stations for each band can be set in the memory.

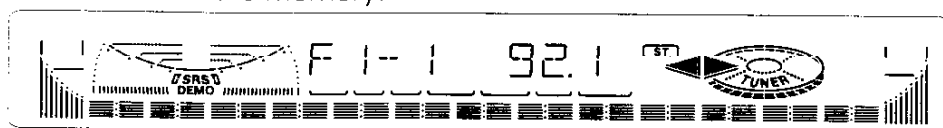

● **Recalling a preset station**

Pressing any number button 1 through 6 will cause the station set in that memory location to be received.

3

Auto Memory

– Automatically searches for broadcast stations and stores them to memory –

● **Starting Auto Memory**

1. Press the FM+ button or the AM– button and select the band that is to be stored to memory from among "F1", "F2", "F3" and "AM".

2. Press the FNC button for 1 second or longer.

"FNC ON" will be displayed and the function set mode enabled.

3. Press the ◀◀ or ▶▶ button to display "A-MEMORY".

4. Press the FM+ or AM– button for 2 seconds or longer to start Auto Memory.

● **Recalling a preset station**

Pressing any number button 1 through 6 will cause the station set in that memory location to be received.

4

Turning CRSC (Clean Reception System Circuit) On/Off

– Reducing multi-path noise –

Temporarily have reception switched from stereo to monaural to reduce multi-path noise when listening to the FM.

Press the CRSC button to turn the function on/off.

The **mc** indicator lights up when CRSC is off.

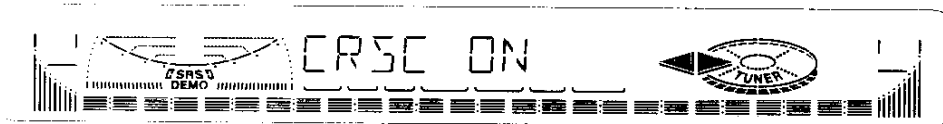

NOTE

Strong electrical fields (such as from power lines) may cause unstable sound quality when CRSC is turned on. In such a situation, turn it off.

TUNER MODE

TUNER MODE

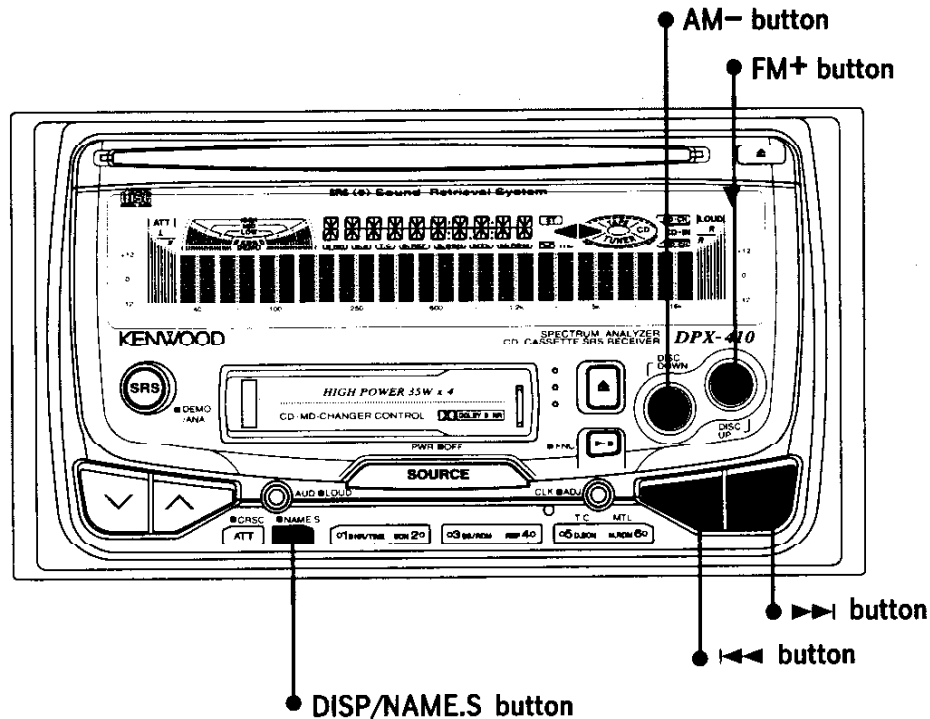

5 Station Name Preset (SNPS) – Assigning names to radio stations –

1. Adjust the frequency to the station whose name you want to enter.
2. Press the NAME.S button for more than 2 seconds.
"NAME SET" will appear in the display and a cursor will blink at the point of input.

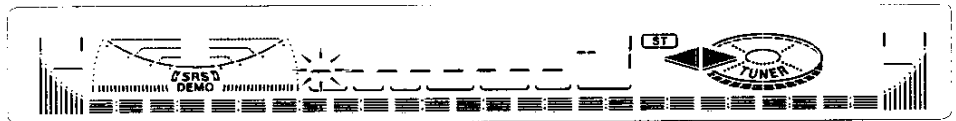

3. Press the left or right arrow button and the cursor will blink at the point you wish to input a character.
4. Press either the FM+ or AM- button to select the character.
Each time the button is pressed, the character type capable of being input will be switched in the order :

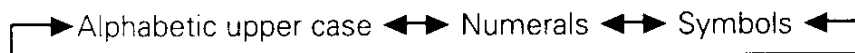

Repeat 3,4 as necessary until you have finished inputting the station name.

NOTE

- When you select (symbols) as the character type to input, you can select from the following : /, +, -, *, =, <, >, [, and]

- You can scroll through the list of characters by holding down the FM+ or AM- button .
 - Up to 8 characters per station name can be input.
 - Use the "_" character listed under symbols to input a space.
5. Press the NAME.S button to register the station name.



NOTE

- If no buttons are pressed for more than 10 seconds, the characters currently entered will be automatically stored in memory as the Station name and the Station Name Preset function will be canceled.
- The numbers that follow the station name display are the button numbers of the tuner memory. Such numbers will not be displayed when the station is not stored by tuner memory.
- Station names for a total of 30 FM/AM stations can be registered. Presetting the station name of the 31st station will result in the automatic deletion of the first station name.
- If you want to change the name of a station, first display the name of the station (following steps 1 and 2 above), then change the letter(s) that you want by following steps 3 through 5.
- Station names remain stored even if the reset button is pressed.

CAUTION

Character input is a complicated operation. The driver should not perform this operation while driving.

6

Station Name Preset Play (SNPP)

– *Searching for the desired station by station name you preset* –

This function is available only via remote control operation. See Page 41 for the detailed operation method.

7

Display Mode Select – *Selecting the display mode* –

Each time the DISP button is pressed, the display will switch in the order:

Frequency Display ↔ SNPS (Station Name Preset) Display

NOTE

"NO NAME" is displayed in the SNPS display if no name has been set using Station Name Preset.

TAPE MODE

TAPE MODE

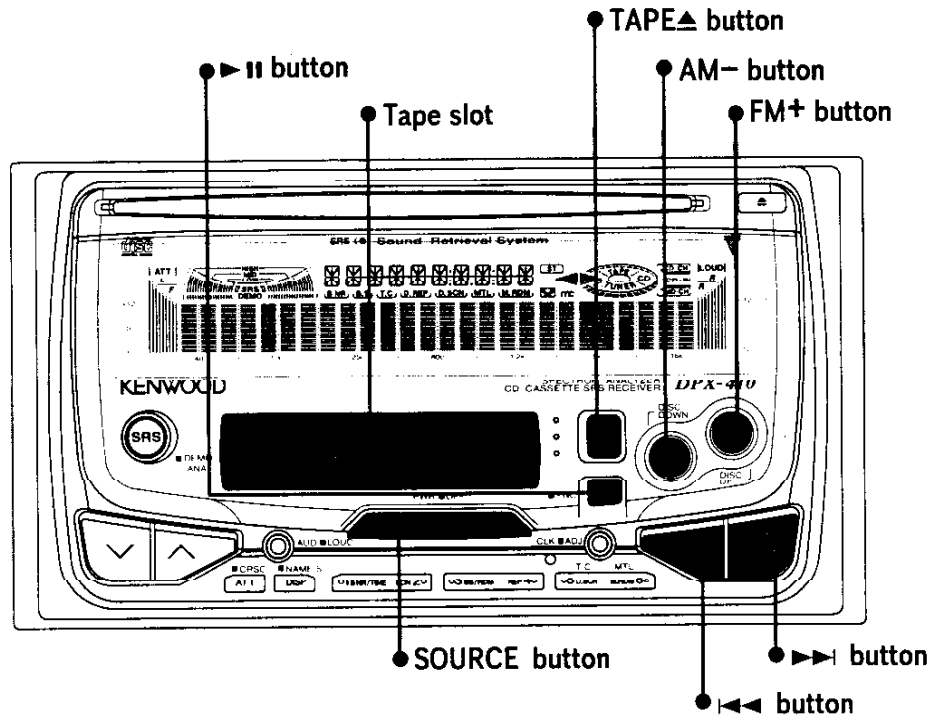



Tape Play/Reverse Play – Playing a cassette tape –

- **When a cassette is not loaded**
Load a cassette with the tape exposed on the right. The  indicator lights up, and the tape play starts.
- **When a cassette is already loaded**
Select "TAPE" in the display by pressing the SOURCE button. The TAPE indicator lights up, and the tape play starts.

Pressing the  button during tape play will cause "REVERSE" or "FORWARD" to be displayed and will switch the side to be playing.



NOTE

- A cassette can be loaded even while the power of the unit is off. Inserting a cassette results in the power being switched on and tape play beginning.
- The tape run indicator informs you that the tape is being transported. When the tape is inserted with Side A facing upward, the  indicator lights while Side A is playing. The  indicator lights while Side B is playing.
- When the tape side to be played is changed, the tape counter display is set to "0:00".

2

Eject – Ejecting a cassette tape –

Pressing the TAPE▲ button will cause the cassette tape to be ejected from the tape slot.

NOTE

The cassette tape can be ejected while another source is set or while the power is off.

3

Fast Forward/Rewind

Press the FM+ button to start fast forward.

Press the AM– button to start rewind.

Press the ►|| button to stop fast forward or rewind.

4

DPSS (Direct Program Search System) – Cueing to tracks –

● **Cueing to the start of the next track**

The number of tracks to be skipped will be displayed each time the ►► button is pressed. The tape will be fast forwarded to the start of the specified track and playback will begin automatically. It is possible to skip up to 9 tracks.

Press the ►|| button to cancel this operation.

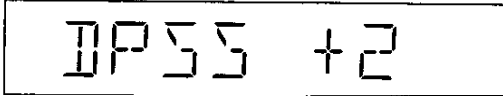

● **Cueing to the start of the previous track**

One press of the ◀◀ button cues to the start of the track to which you are currently listening. Each press of the button results in the display of the number of skipped tracks.

The tape will be rewound to the start of the specified track and playback will begin automatically. It is possible to skip up to 9 tracks.

Press the ►|| button to cancel this operation.

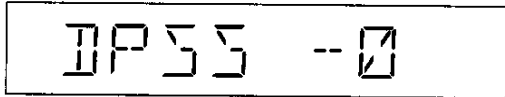

NOTE

DPSS is implemented by searching for the blank part between tracks. It is therefore impossible to accurately search for tracks in the case of tapes where the blank part between tracks is less than 4 seconds, or when extremely low sound levels within a track last for more than 4 seconds as this portion of the track may be mistaken for the beginning of a track.

TAPE MODE

TAP
E
M
O
D
E

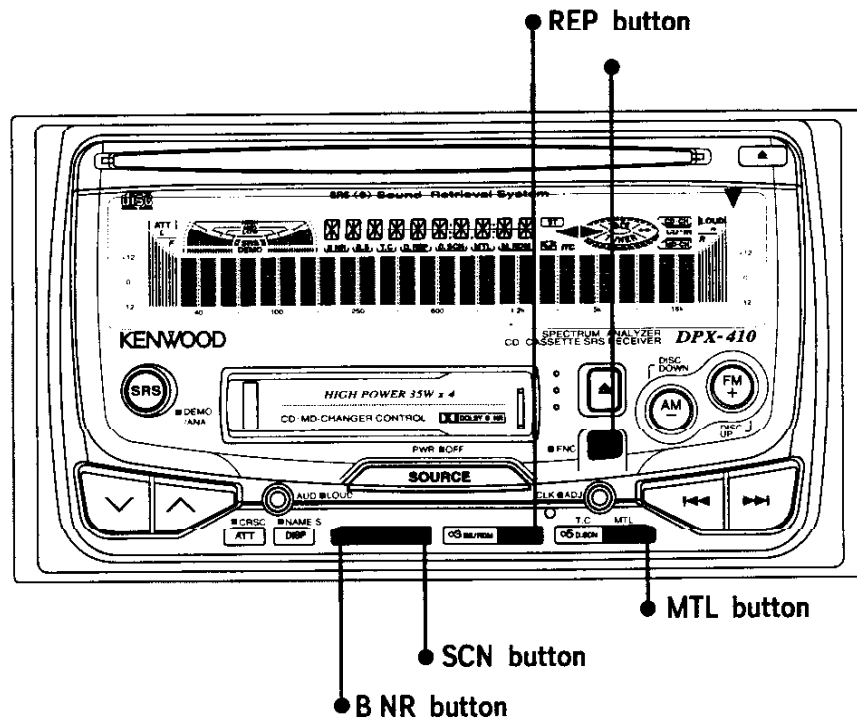

5 Switching the Tape Type – Listening to Metal/CrO₂ tapes –

Each time the MTL button is pressed, the tape type will be switched as follows.

"METAL ON" Metal (Type IV) / CrO₂ (Type II)

The MTL indicator lights up.

"METAL OFF" .. Normal (Type I)

The MTL indicator disappears.

Select the tape type according to the tape to be playing.

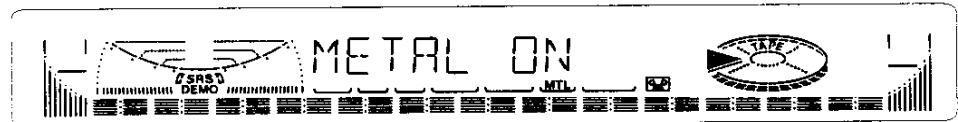

6 Dolby B NR System – Listening to tapes recorded using Dolby B NR –

Each time the B NR button is pressed, "B NR ON" or "NR OFF" is displayed and the unit will switch noise reduction system on and off.

The B NR indicator lights when it is turned on. Turn this function on when playing a tape recorded using Dolby B NR.

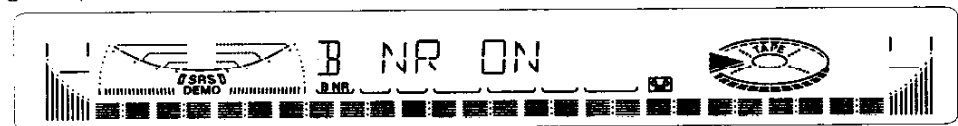

Dolby Noise reduction is manufactured under license from the Dolby Laboratories Licensing Corporation. Dolby and the double D symbol are registered trademarks of the Dolby Laboratories Licensing Corporation.

7

Repeat Play – Listening to the same track repeatedly –

Repeat play is switched on and off each time the REP button is pressed. "REPEAT ON" is displayed and the REP indicator lights when the function is turned on.

The track currently being listened to will repeat indefinitely.



8

Index Scan Play – Searching for a desired track –

1. Index Scan Play is switched on and off each time the SCN button is pressed. "INDEX SCAN" is displayed and the SCN indicator will blink when the function is turned on.

During Index Scan Play, the unit will cue to the start of each track and play the first 10 seconds.

2. Press either the SCN or ►|| button to stop to listen to the track being scanned. Playback begins as usual.

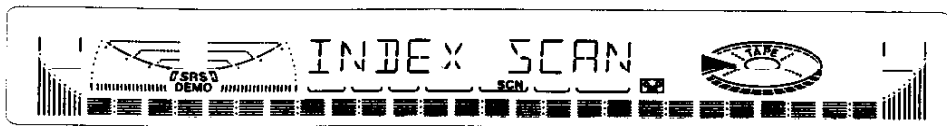

NOTE

Repeat Play, and Index Scan Play are implemented by searching for the blank part between tracks. It is therefore impossible to accurately search for tracks in the case of tapes where the blank part between tracks is less than 4 seconds, or when extremely low sound levels within a track last for more than 4 seconds as this portion of the track may be mistaken for the beginning of a track.

TAPE MODE

TAPE MODE

TAPE MODE

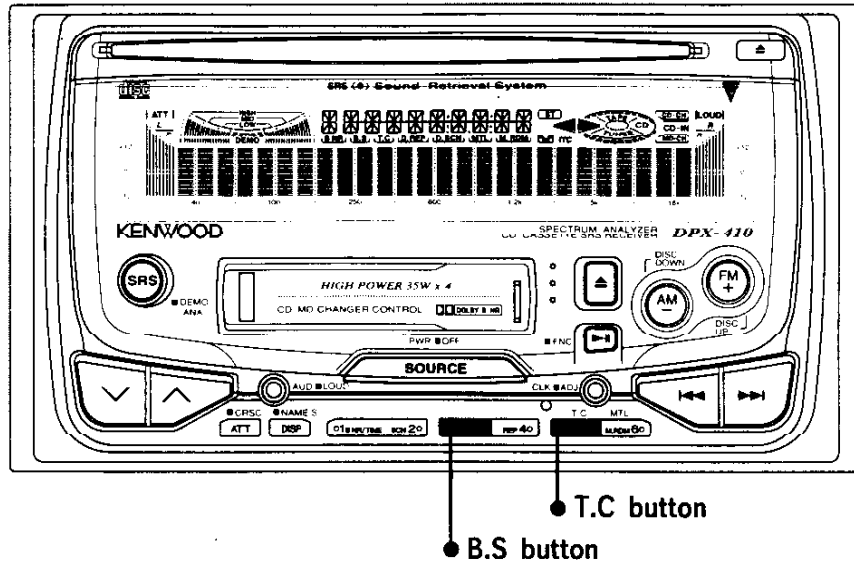

9

Blank Skip – Skipping blank sections of tape –

Blank Skip is switched on and off each time the B.S button is pressed. "B-SKIP ON" is displayed and the B.S indicator lights when the function is turned on.

If a blank portion of tape lasting 10 seconds or more is encountered, the unit will automatically fast forward to the next track.



NOTE

If the noise in the blank part of a tape is too loud, the Blank Skip function may fail to fast forward past it. Also, if a 10-second or longer portion within a track has been recorded at a very low sound level, as is common in classical music, the Blank Skip function may activate and skip this part. Turn the Blank Skip function off if this happens. The Blank Skip function is turned on by default.

10

Tuner Call

- Listening to the radio broadcasting during fast forwarding or rewinding -

Tuner call is switched on and off each time the T.C button is pressed. "T-CALL ON" is displayed and the T.C indicator lights when the function is turned on.

The T.C indicator will blink and the radio broadcasting will be received whenever the tape is being fast forwarded or rewound.

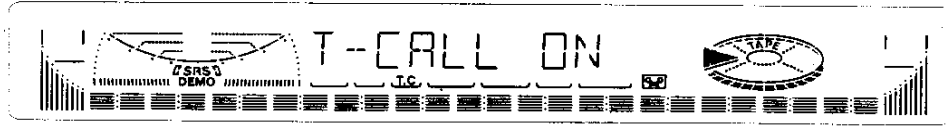

NOTE

- For cars using auto antennas, the antenna will remain extended while the Tuner Call function is on. Be sure to turn Tuner Call off when you wish to retract the antenna such as when parking the car in a garage.
- Tuner Call cannot be used during DPSS.
- During Tuner Call, the station that was received prior to listening to the tape is received. Changing to another station is not possible.

TAPE MODE

CD MODE

CD MODE

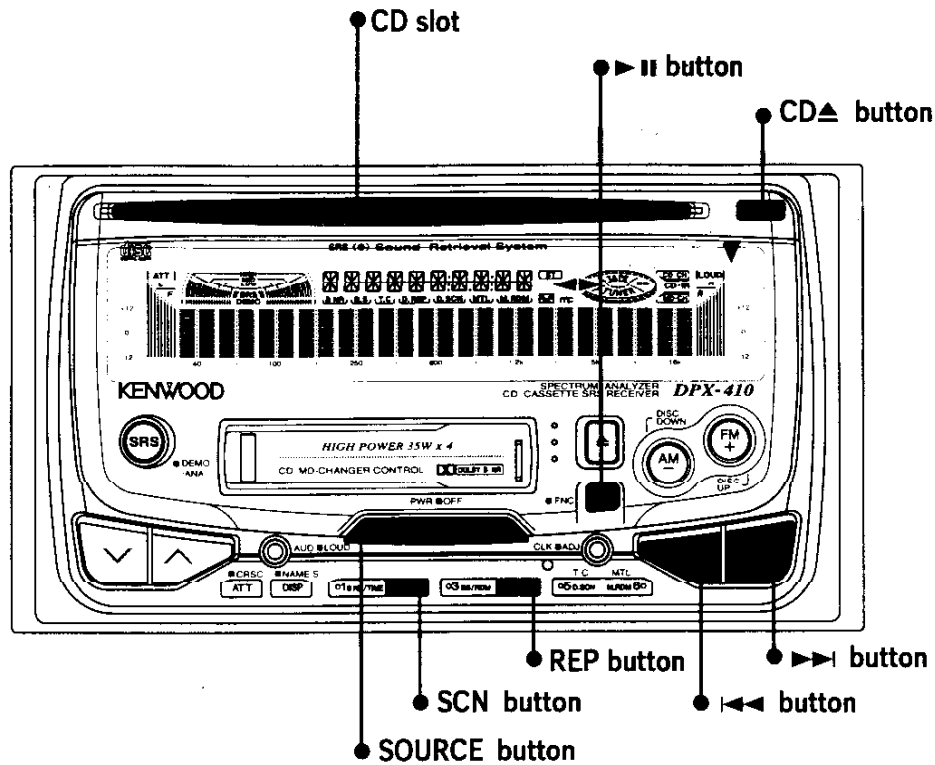

CD Play/Pause – Listening to a CD –

● When a CD is not inserted

Holding the CD with the labeled side facing up, insert it in the slot. The CD-IN indicator will light, and the track No. and Time display will appear and CD play will begin.

● When a CD is already inserted

Select "CD" in the display by pressing the SOURCE button. The CD indicator will light and CD play will begin.

Pressing the ►|| button during CD play will pause CD playback. Pressing the ►|| button again will resume CD playback.

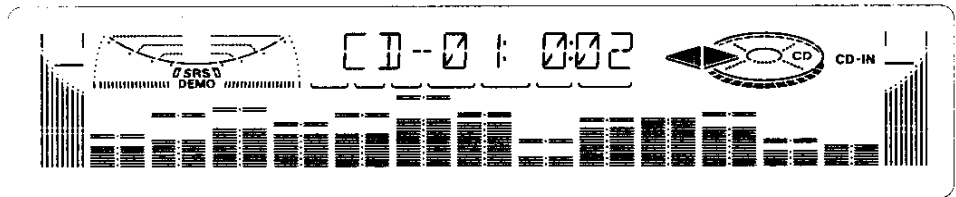

CAUTION

Load 8-cm CDs without using an adaptor. They can be played back as is just like 12-cm CDs. Use of an adaptor for 8-cm CDs may result in malfunction or damage to the system.

2 Eject – Ejecting a CD –
 CDs can be ejected by pressing the CD▲ button.

NOTE

- When a CD has not been loaded, the eject mechanism will operate even if the CD▲ button is pressed. If a CD is inserted soon after pressing the button in this situation, the CD may be scratched. Wait a little while before inserting the CD.
- When you eject a CD immediately after loading it, it is sometimes not possible to load it again even if you push the CD. If this happens, remove the CD from the slot and try again.

3 Track Search – Searching for a desired track –

● **Cueing to the start of the next track**

Each time the ►► button is pressed, the unit will search for the start of the next track.

Holding down the ►► button will fast forward through the current track.

● **Cueing to the start of the previous track**

One press of the ◀◀ button cues to the start of the track to which you are currently listening. Each press of the button results in a track search to the previous track.

Holding down the ◀◀ button will rewind through the current track.

4 Track Repeat Play – Listening to the same track repeatedly –

Track Repeat Play is switched on and off each time the REP button is pressed. "REPEAT ON" is displayed and the REP indicator lights when the function is turned on. During Track Repeat Play, the current track No. will blink. The track currently being listened to will repeat indefinitely.



5 Track Scan Play – Searching for a desired track –

1. Track Scan Play is switched on and off each time the SCN button is pressed. "SCAN" is display and the SCN indicator lights when the function is turned on. During Track Scan Play, the current track No. will blink. The unit cues each track on the current disc and plays back the first 10 seconds.
2. Press either the SCN or ►|| button to stop to listen to the track being scanned. Playback begins as usual.

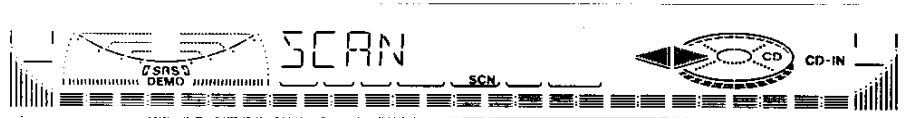

NOTE

Track Scan Play will turn off automatically after all tracks have been scanned.

CD MODE

CD MODE

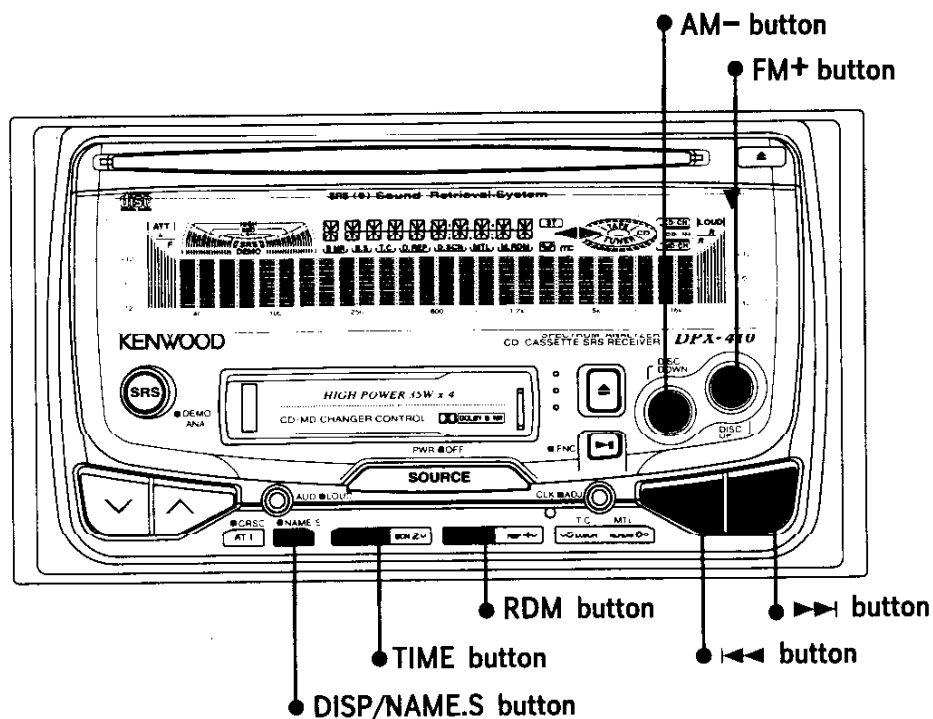

- 6** **Track Random Play** – *Listening to tracks on the current disc in random order* – Track Random Play is switched on and off each time the RDM button is pressed. "RANDOM" is displayed and the RDM indicator lights when the function is turned on. During Track Random Play, the current track No. blinks. Each time a track ends, the next track for playback is randomly selected automatically. Pressing the \gg button at any time will automatically select the next track for playback.



- 7** **Disc Name Preset (DNPS)** – *Entering a name for a disc* –
1. Play the disc you wish to name.
 2. Press the NAME.S button for more than 2 seconds. "NAME SET" will appear in the display and a cursor will blink at the point of input.

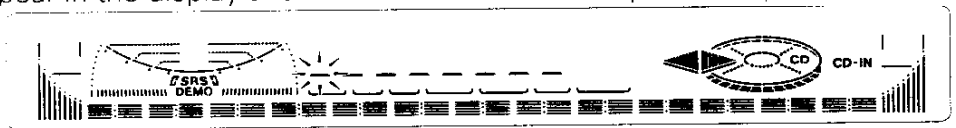

3. Press the \gg or \ll button and the cursor will blink at the point you wish to input a character.

4. Press either the FM+ or AM- button to select the character. Each time the button is pressed, the character type capable of being input will be switched in the order:



Repeat 3,4 as necessary until you have finished inputting the disc name.

NOTE

- When you select (symbols) as the character type to input, you can select from the following: /, +, -, *, =, <, >, [, and]
 - You can scroll through the list of characters by holding down the FM+ or AM- button.
 - Up to 8 characters per disc name can be input.
 - Use the "_" character listed under symbols to input a space.
5. Press the NAME.S button to register the disc name.

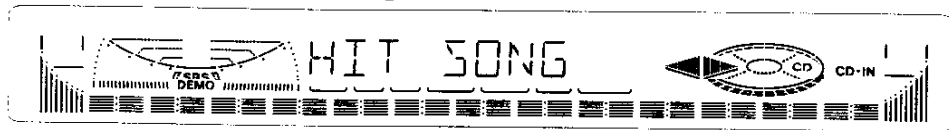

NOTE

- If no buttons are pressed for more than 10 seconds, the characters currently entered will be automatically stored in memory as the Disc name and the Disc Name Preset function will be canceled.
- Up to 10 disc names can be registered in CD Mode using Disc Name Preset. Once the 11st Disc Name Preset is made, the oldest Disc Name Preset will be automatically erased to make room for the new setting.
- If you want to change the name of a disc repeat steps 1 and 2 to display the name, and then repeat steps 3 through 5 to input the changes.
- Discs that have been disc name preset with the CD changer will not have their disc name displayed when played on a CD player.
- Disc names remain stored even if the reset button is pressed.
- Discs are identified by their total recording time and number of tracks. Correct identification is not possible if two discs happen to have the same total recording time and number of tracks.

CAUTION

Character input is a complicated operation. The driver should not perform this operation while driving.

8

Time Display Mode Select - Selecting the time display mode -

Each time the TIME button is pressed, the time display will switch in the order:



9

Display Mode Select - Selecting the display mode -

Each time the DISP button is pressed, the display will switch in the order:

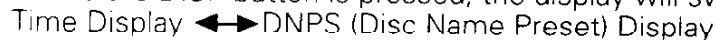

NOTE

"NO NAME" is displayed in the DNPS display if no name has been set using Disc Name Preset.

DISC CHANGER CONTROL MODE

DISC CHANGER CONTROL MODE

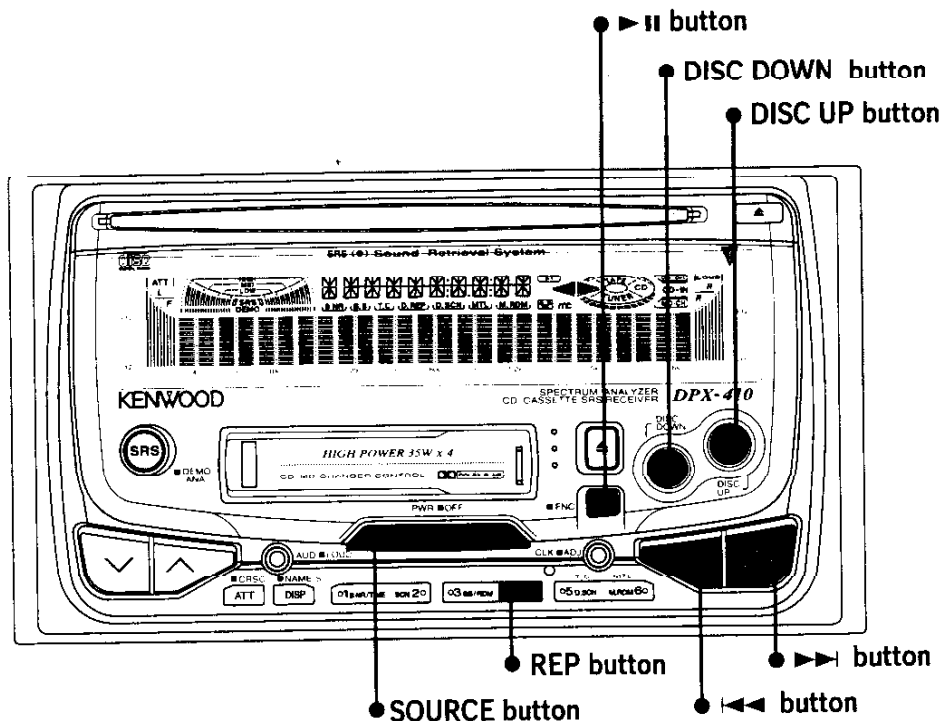

Disc Play/Pause – Listening to a disc changer play –

Select "DISC-CH" in the display by pressing the SOURCE button. Either the CD-CH or MD-CH indicator will light up and the Disc/Track No. and Time display will appear. Disc playback will begin. Pressing the >|| button during disc playback will cause the Time display to blink and pause disc playback. Pressing the >|| button again will resume disc playback.

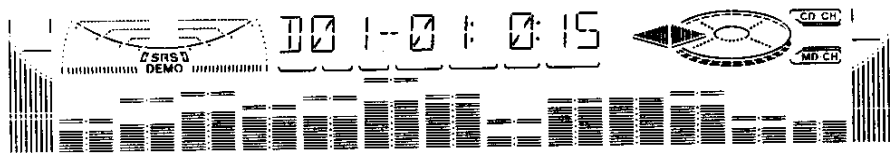

NOTE

The CD-CH indicator will light when a CD changer is playing and the MD-CH indicator will light when an MD changer is playing.

2

Disc Changer Select – Selecting from two disc changers –

When two disc changers are connected, the disc changer mode divides into DISC-CH1 and DISC-CH2.

Press the SOURCE button and select the disc changer that is to be used.

NOTE

A separately sold KCA-S200 CD/MD Changer Switching Unit is required in order to connect two disc changers.

When the KDC-C810 is the directly connected disc changer (DISC-CH1), two units may be controlled even without the KCA-S200.

3

Track Search – Searching for a desired track –

● **Cueing to the start of the next track**

Each time the ►► button is pressed, the unit will search for the start of the next track.

Holding down the ►► button will fast forward through the current track.

● **Cueing to the start of the previous track**

One press of the ◀◀ button cues to the start of the track to which you are currently listening. Each press of the button results in a track search to the previous track.

Holding down the ◀◀ button will rewind through the current track.

4

Disc Search – Listening to a desired disc –

● **Selecting the next disc**

The unit will search for the next disc each time the DISC UP button is pressed.

● **Selecting the previous disc**

The unit will search for the previous disc each time the DISC DOWN button is pressed.

5

Track/Disc Repeat Play – Listening to the same track or disc repeatedly –

Each time the REP button is pressed, the repeat play mode will be switched in the order.



● **Track Repeat play**

When the function is turned on, the REP indicator lights.

During track repeat play, the track No. will blink. The current track will be repeated indefinitely.



● **Disc Repeat Play**

When the function is turned on, the D.REP indicator lights.

During disc repeat play, the disc No. will blink. The current disc will be repeated indefinitely.



DISC CHANGER CONTROL MODE

DISC CHANGER CONTROL MODE

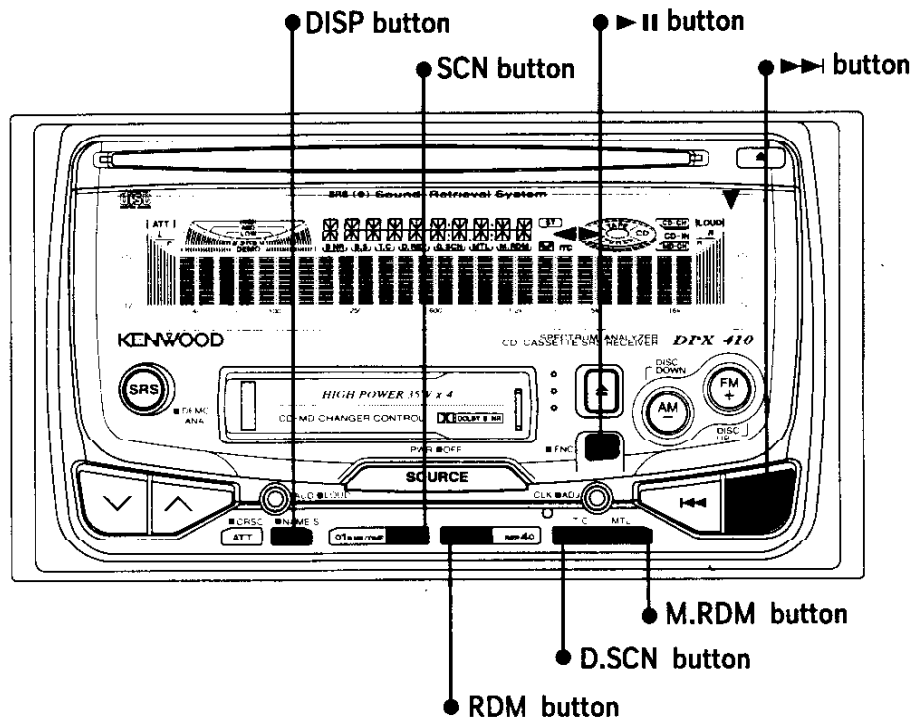

6

Track Scan Play – Searching for a desired track –

1. Track Scan Play is switched on and off each time the SCN button is pressed. "T-SCAN" is displayed and the SCN indicator lights when the function is turned on. During Track Scan Play, the current track No. will blink. The unit cues each track on the current disc and plays back the first 10 seconds.
2. Press either the SCN or >|| button to stop to listen to the track being scanned. Playback begins as usual.



NOTE

Track Scan Play will turn off automatically after all tracks have been scanned.

7

Disc Scan Play – Searching for a desired disc –

1. Disc Scan Play is switched on and off each time the D.SCN button is pressed. "D-SCAN" is displayed and the D.SCN indicator lights when the function is turned on. During Disc Scan Play, the current disc No. will blink. The unit cues the first track on each disc and plays back the first 10 seconds.

- Press either the D.SCN or ►|| button to stop to listen to the disc being scanned. Playback begins as usual.



NOTE

Disc Scan Play will turn off automatically after all discs have been scanned.

8

Track Random Play – Listening to tracks on the current disc in random order –

Track Random Play is switched on and off each time the RDM button is pressed. "RANDOM" is displayed and the RDM indicator lights when the function is turned on. During Track Random Play, the current track No. blinks. Each time a track ends, the next track for playback is randomly selected. Pressing the ►► button at any time will automatically select the next track for playback.



9

Magazine Random Play – Listening to tracks in the magazine in random order –

Magazine Random Play is switched on and off each time the M.RDM button is pressed. "M-RANDOM" is displayed and the M.RDM indicator lights when the function is turned on. During Magazine Random Play, the current track No. and disc No. blinks. Each time a track ends, the next track for playback is randomly selected from within the magazine.

Pressing the ►► button at any time will automatically select the next track for playback.



10

Display Mode Select – Selecting the display mode –

Each time the DISP button is pressed, the display will be switched in the order given below:

● **CD changer play**

Time Display ↔ DNPS (Disc Name Preset) Display

● **MD changer play**

Time Display ► DNPS (Disc Name Preset) Display ► Disc Title Display
 Track Title Display ◀

NOTE

- "NO NAME" is displayed in the disc name display if no name has been set using Disc Name Preset.
- "NO NAME" is also displayed if no disc title or track title is recorded on the MD.



DISC CHANGER CONTROL MODE

DISC CHANGER CONTROL MODE

DISC CHANGER CONTROL MODE

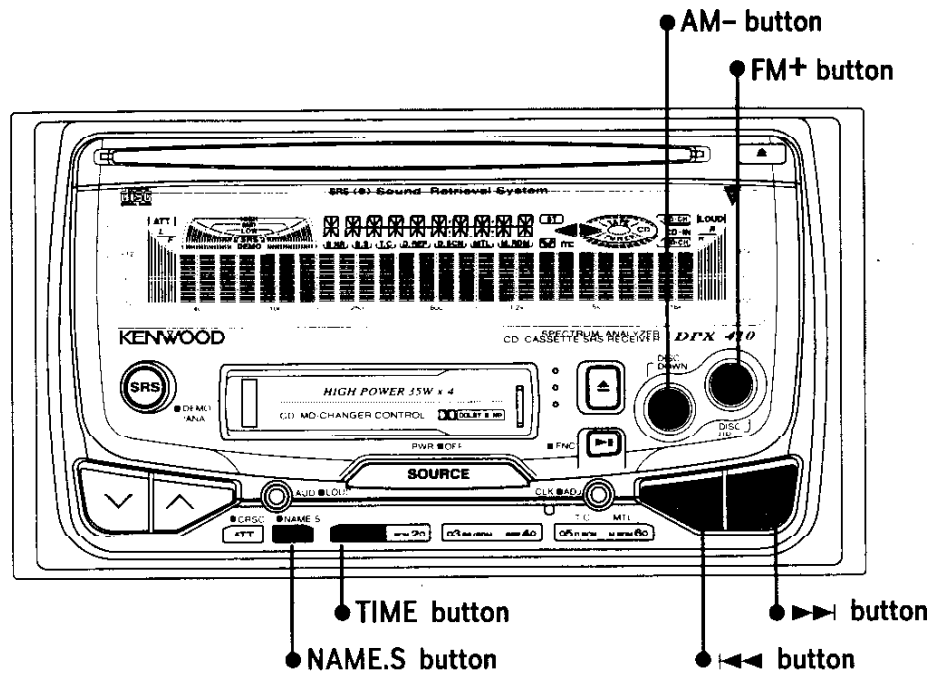

Time Display Mode Select – Selecting the time display mode –

Each time the TIME button is pressed, the time display will be switched in the order:



NOTE

Only Track Play Time display is available during MD play.



Disc Name Preset (DNPS) – Entering a name for a disc –

1. Play the disc you wish to name.
2. Press the NAME.S button for more than 2 seconds. "NAME SET" will appear in the display and a cursor will blink at the point of input.



3. Press the ►► or ◀◀ button and the cursor will blink at the point you wish to input a character.
4. Press either the FM+ or AM- button to select the character. Each time the button is pressed, the character type capable of being input will be switched in the order:



Repeat 3,4 as necessary until you have finished inputting the disc name.

NOTE

- When you select (symbols) as the character type to input, you can select from the following : /, +, -, *, =, <, >, [, and]
 - You can scroll through the list of characters by holding down the FM+ or AM- button .
 - Up to 8 characters per disc name can be input.
 - Use the "-" character listed under symbols to input a space.
5. Press the NAME.S button to register the disc name.

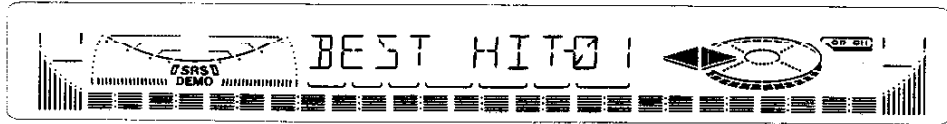

NOTE

- If no buttons are pressed for more than 10 seconds, the characters currently entered will be automatically stored in memory as the Disc name and the Disc Name Preset function will be canceled.
- The number of discs for which disc names can be registered will differ depending on the disc changer that is connected. The disc changers which can accommodate disc name presets are as listed below.

Disc changer name	Number of discs that can be name preset
KDC-C604, KMD-C80	30 discs
KDC-C710, KDC-C660	50 discs
KDC-C810	100 discs

- This procedure is not to be used to store the disc and track titles for MDs that you record.
- If you want to change the name of a disc repeat steps 1 and 2 to display the name, and then repeat steps 3 through 5 to input the changes.
- Each source (CD, DISC-CH1, DISC-CH2) has its own memory in which to store the disc names.
Discs that have been disc name preset with the CD player will not have their disc name displayed when played on a CD changer.
- Disc names remain stored even if the reset button is pressed.
- Discs are identified by their total recording time and number of tracks.
Correct identification is not possible if two discs happen to have the same total recording time and number of tracks.

CAUTION

Character input is a complicated operation. The driver should not perform this operation while driving.

13

Disc Name Preset Play (DNPP)

- Searching for the desired disc by disc name you preset -

This function is available only via remote control operation. See Page 41 for the detailed operation method.

OTHER MODE

OTHER MODE

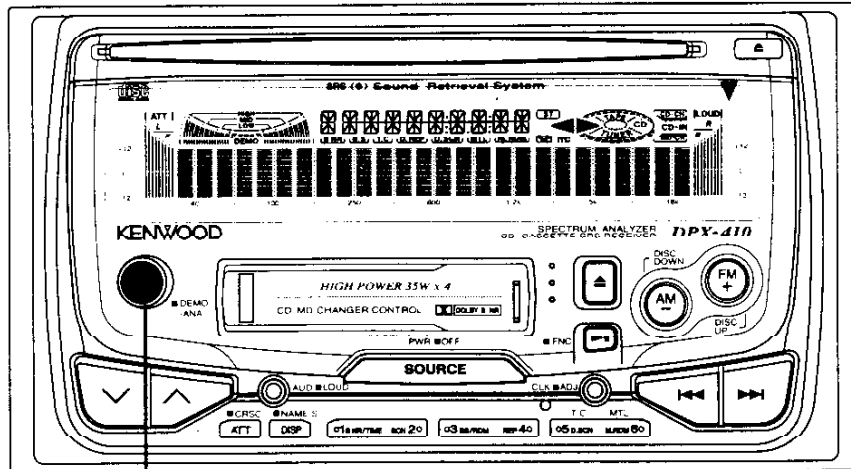

● SRS/DEMO/ANA button



SRS (Sound Retrieval System) Setting Change

– Switching the acoustic effect among 3 levels –

Each press of the SRS button switches the acoustic effect setting one step in the following order.

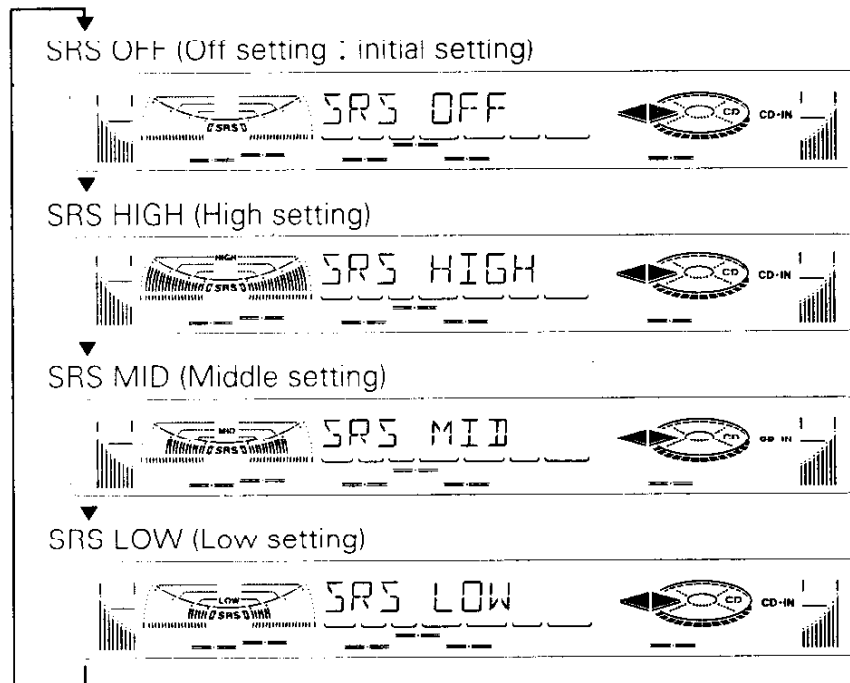

2

Spectrum Analyzer Display Select – Selecting the display to enjoy sounds with eyes –

1. Press the DEMO/ANA button for more than one second to switch to Spectrum Analyzer control mode.
2. Each time the DEMO/ANA button is pressed, the spectrum analyzer display will switch in order from 1 to 10.

NOTE

- If no buttons are pressed for more than 10 seconds, the spectrum analyzer control mode is automatically canceled.
- The initial setting is 1. DEMO mode.

1. DEMO mode

This mode displays spectrum analyzer displays 2 through 10 in sequence for 10 seconds each.

6. Blizzard spectrum analyzer



2. Peak Hold spectrum analyzer



7. Cross Beam spectrum analyzer

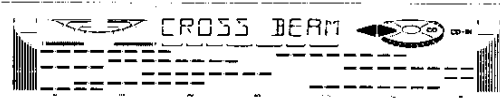

3. Jump Up spectrum analyzer

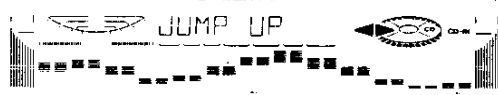

8. Kiss spectrum analyzer

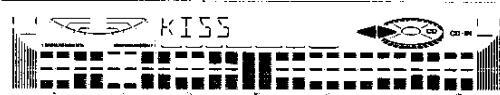

4. Block Falls spectrum analyzer

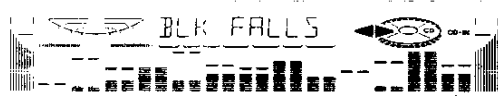

9. Rain Drop spectrum analyzer

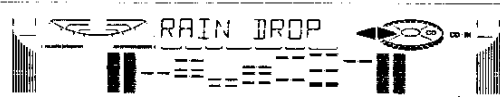

5. Slot spectrum analyzer



10. Side Wave spectrum analyzer

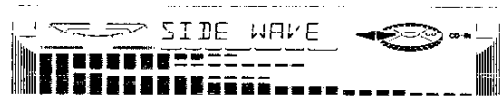

3. Press the DEMO/ANA button for more than 1 second to end the Spectrum Analyzer control mode.

OTHER MODE

REMOTE CONTROL MODE

REMOTE CONTROL MODE

ALL MODE

- **TUNER button**
Turns the radio reception on.
Pressing this button during radio reception will turn the source mode to the ALL OFF mode.
- **TAPE button**
Starts tape play when pressed when a tape is loaded.
- **CD button**
Starts CD play when pressed when a CD is inserted.
- **CD•MD CH button**
Starts disc changer play when pressed.
Switches between disc changer 1 and 2 when two changers are connected.
- **VOL. buttons**
Volume level can be adjusted with the \wedge/\vee buttons.

TUNER MODE

- **Number buttons**
1 through 6 are used to recall stations stored in memory.
0 through 9 are also used to directly input frequencies during tuning.
- **DIRECT button**
Turns frequency input mode on/off each time pressed.
Number buttons are used to input the frequency of the desired station while the frequency display blinks (for ten seconds).
Examples : FM 92.1 MHz
Number buttons to press.....**9 2 1**
AM 810 kHz
Number buttons to press.....**8 1 0**
- **◀◀/▶▶ buttons**
Pressing the **◀◀** button decreases the frequency being received.
Pressing the **▶▶** button increases the frequency being received.
- **FM button**
Switches between the FM1, FM2 and FM3 bands each time pressed.
- **AM button**
Switches to the AM band.

■ TAPE MODE

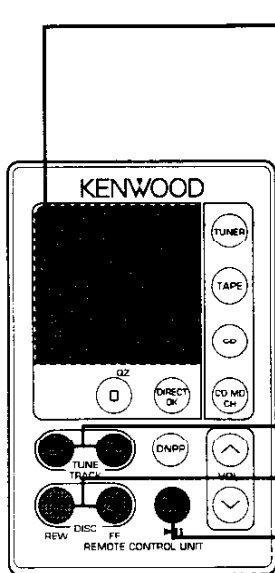

- **Number buttons**
Use to input the number of tracks to be skipped. Pressing the ◀◀ button while the number display is blinking (for ten seconds) will cause the unit to rewind the number of tracks indicated and begin tape play. Pressing the ▶▶ button while the number display is blinking (for ten seconds) will cause the unit to fast forward the number of tracks indicated and begin tape play.
- **◀◀/▶▶ buttons**
The ◀◀ button performs DPSS to the beginning of the current track, and to the previous track each time it is pressed thereafter. The ▶▶ button performs DPSS to the next track.
- **REW/FF buttons**
Pressing the REW button will start rewind. Pressing the FF button will start fast forward.
- **PROG button**
Pressing this button will result in reverse play. Tape play is resumed if this button is pressed during rewind, fast forward, or DPSS.

■ CD/DISC CHANGER MODE

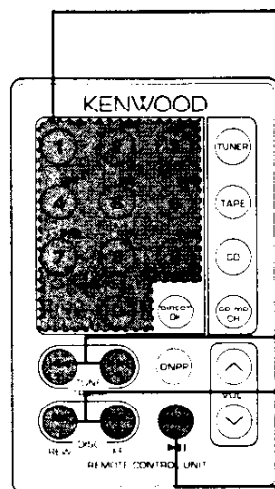

- **Number buttons**
Use to input the track or disc number to be played. Pressing the ◀◀ or ▶▶ button while the number display is blinking (for ten seconds) results in track search. Pressing the - or + button while the number display is blinking (for ten seconds) results in disc search.
- **◀◀/▶▶ buttons**
Pressing the ◀◀ button once will cause the unit to track search to the beginning of the current track, and to the previous track each time it is pressed thereafter. Pressing the ▶▶ button will cause the unit to track search to the beginning of the next track.
- **-/+ buttons**
Pressing the - button will start play of the previous disc. Pressing the + button will start play of the next disc.
- **▶|| button**
Plays/pauses disc play.

REMOTE CONTROL MODE

REMOTE CONTROL MODE

■ SNPS/DNPS MODE

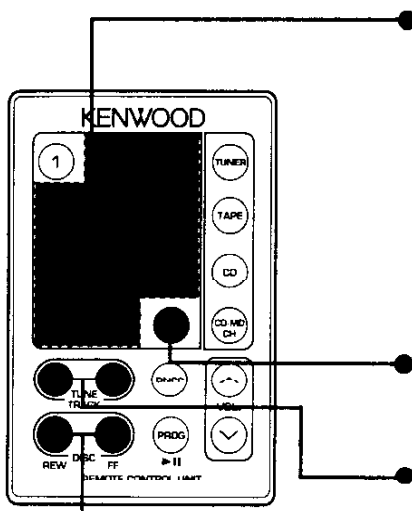

● Letter entry buttons

Use to enter letters (alphabetical) during station/disc name preset mode.

Example : Use the following table to enter the name "DANCE".

Character	Button to press	#Times pressed
"D"	#3	1
"A"	#2	1
"N"	#6	2
"C"	#2	3
"E"	#3	2

● OK button

Use to store the already input station/disc name data in memory and end the input mode.

● ◀▶ buttons

Moves the cursor left or right.

● -/+ buttons

Selects digits and symbols.

■ SNPP/DNPP MODE

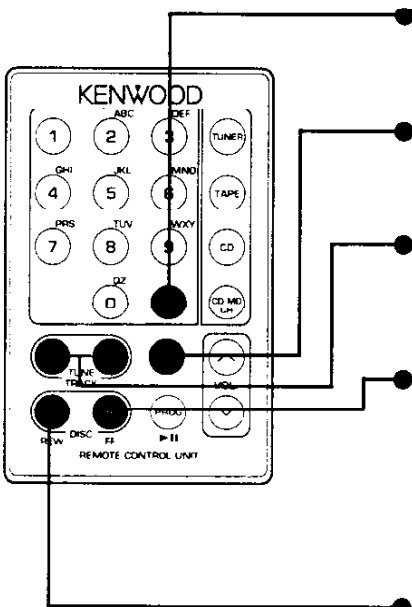

● OK button

Use to select the station/disc during the station/disc name preset play mode.

● DNPP button

Enters and cancels the station/disc name preset play mode.

● ◀▶ buttons

Pressing the ▶▶ button will switch the station display in the forward direction and pressing the ◀◀ button will switch in the reverse direction during SNPP mode.

● FM/DISC+ button

Pressing the FM button during the SNPP mode will switch between the FM1, FM2 and FM3 displays in that order.

Pressing the DISC+ button during DNPP mode will switch the disc name displays rapidly in the forward order.

● AM/DISC- button

Pressing the AM button during SNPP mode will switch to the AM display.

Pressing the DISC- button during DNPP mode will switch the disc name displays rapidly in the reverse order.

SNPP/DNPP OPERATIONS



Station Name Preset Play (SNPP)

- Searching for the desired station by station name you preset -

1. Press the DNPP button on the remote control during tuner mode. "SNP PLAY" will be displayed once the station name preset play (SNPP) mode is entered.
The names of the stations stored in the band currently listened to are displayed in the following order for five seconds each:
FM1, FM2, FM3 and AM.
Each time the ◀◀ or ▶▶ button is pressed, the station display switches in the forward or reverse direction.

6-MUSIC ST

NOTE

- Stations whose names have not been stored will be displayed as frequencies.
 - If you want to change the displayed band, press the FM button to switch between the FM1, FM2 and FM3 displays in that order, and press the AM button to switch to the AM display.
2. Press the OK button once the name is displayed for the station you want to listen to.
Reception starts of the displayed station, and the station name preset play mode ends.

NOTE

Press the DNPP button to cancel the SNPP mode during input



Disc Name Preset Play (DNPP)

- Searching for the desired disc by disc name you preset -

1. Press the DNPP button on the remote control during disc changer mode. "DNP PLAY" will appear in the display, and the disc name preset play (DNPP) mode is entered.
The names of all the discs in the disc changer will appear successively in the display for five seconds each
Each time the DISC+ or DISC- button is pressed, the disc name display switches rapidly in the forward or reverse order.

2-JAZZ HIT

NOTE

- Discs whose names have not been preset will appear as "NO NAME" in the display.
 - Discs in the disc changer that have never been played before will appear as "NO ACCES" when the disc names are displayed. When you cannot identify a disc because of the "NO ACCES" display after inserting a disc magazine, try playing it using the disc scan or a similar function to display the disc name. "NO ACCES" will also be displayed when a disc has not been loaded.
 - The DNPP function can be used only when a disc changer from among the following is connected.
KDC-C810, KDC-C710, KDC-C660, KMD-C80, KDC-C604
2. Press the OK button when the name appears for the disc you want to play.
The disc whose name is displayed will be recalled, and the disc name preset play (DNPP) mode will end.

NOTE

Press the DNPP button to cancel the DNPP mode during input.



REMOTE CONTROL MODE

CONNECTIONS

First check that the engine key is removed, and disconnect the negative terminal of the battery to prevent any accidents due to shorting.

1. Check the input/output wires of each unit and connect.
2. Connect the speaker wires of the power harness.
3. Connect the power harness in order of ground wire (black), battery wire (yellow), ignition wire (red).
4. Connect the power harness connector to the DPX-410.
5. After installation is complete, re-connect the negative terminal of the battery.
6. Press the reset button.

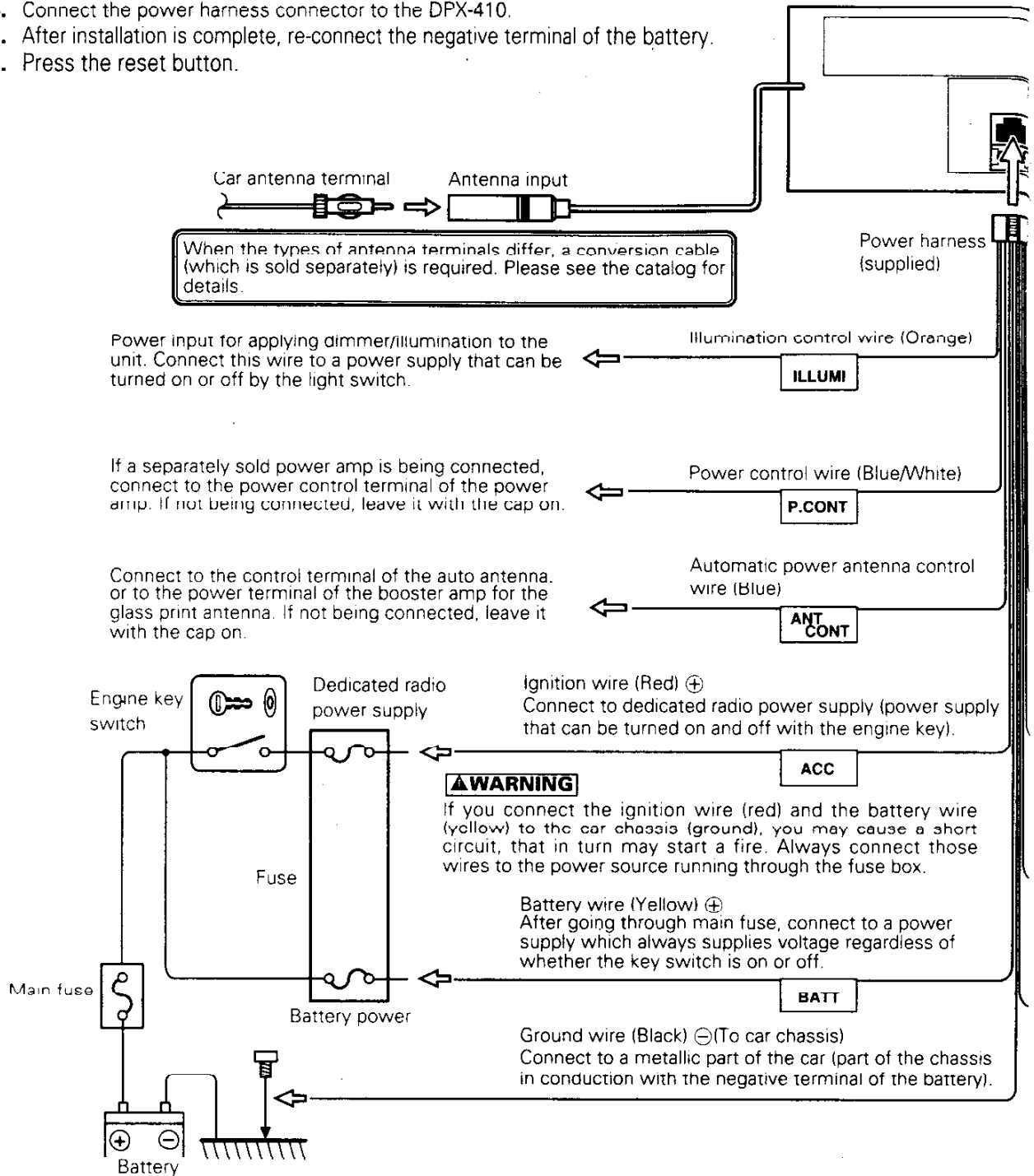

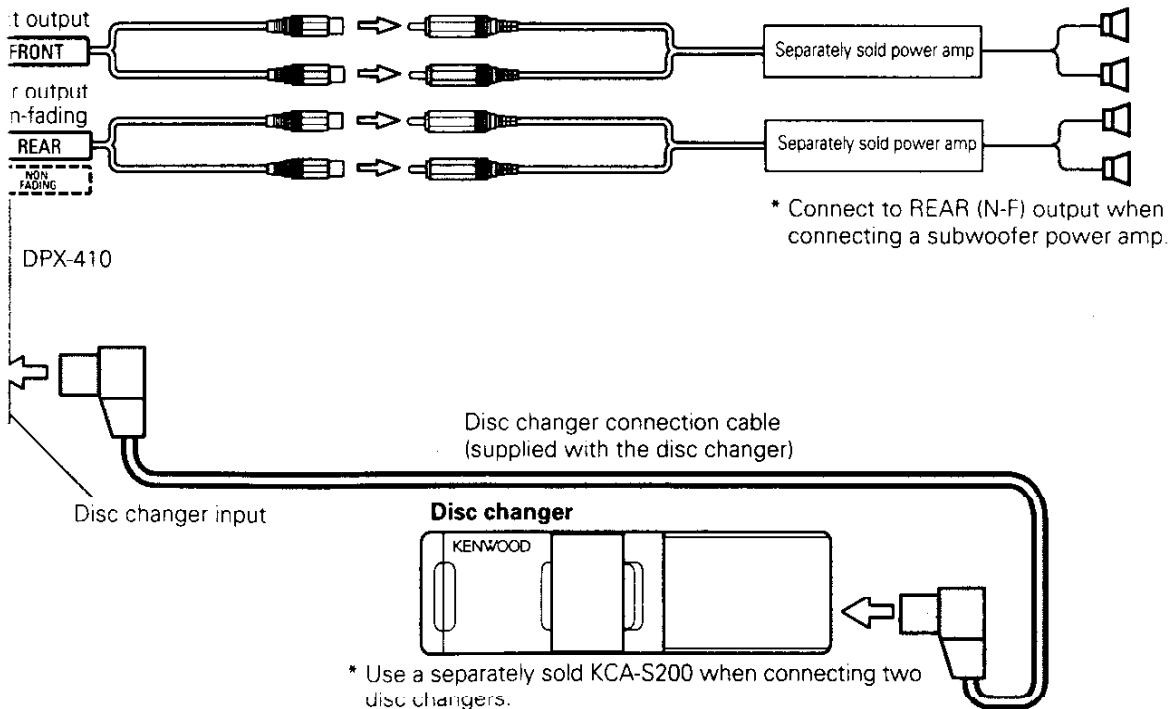

* Connect to REAR (N-F) output when connecting a subwoofer power amp.

* Use a separately sold KCA-S200 when connecting two disc changers. When the KDC-C810 is the directly connected disc changer (DISC-CH1), two units may be controlled even without the KCA-S200.

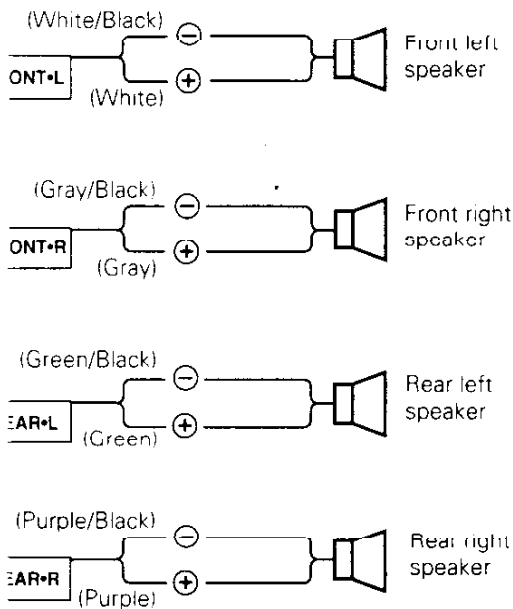



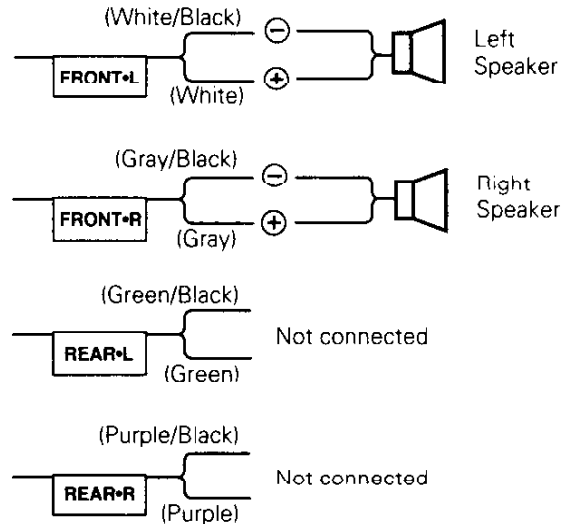





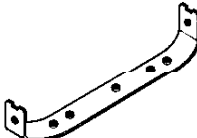

Speaker Connections when Using Two Speakers

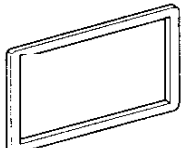

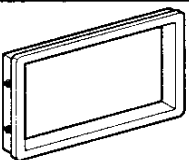
CAUTION

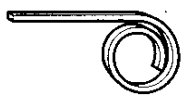
When only two speakers are being connected to the system, connect the connectors either to both the front output terminals or to both the rear output terminals (do not mix front and rear). For example, if you connect the ⊕ connector of the speaker to a front output terminal, do not connect the ⊖ connector to a rear output terminal.

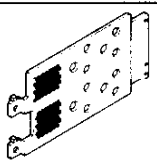
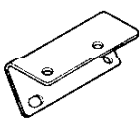
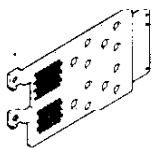
ACCESSORIES FOR INSTALLATIONS

No.	External View	Number of Items	No.	External View	Number of items
①		6	⑧		1
②		1	⑨		6
③		1	⑩		8
④		1	⑪		2
⑤		1	⑫		1
⑥		1	⑬		1
⑦		1	⑭		4

⚠ CAUTION

Do not use any accessories other than those provided with your unit. If you use other accessories, you may damage the unit.

REPLACING THE FUSE

⚠ CAUTION

When the fuse has blown, check that the cord is not shorted, then be sure to replace the fuse with a new one of the capacity (number of Amperes) indicated on the original fuse. Use of a fuse other than one of the rated capacity may be the cause of fire.

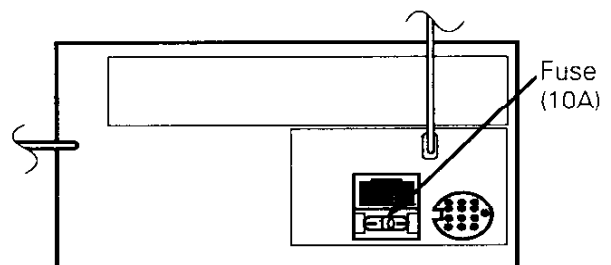

INSTALLATION (for Non-HONDA ACURA Car)

▲ CAUTION

When performing a check of the CD operation prior to installation, place this unit in a horizontal position and perform a loading/eject of the CD.

■ Installation

Install onto the car bracket using the supplied screws (Ø5 × 8 mm).
The number of screws to use will differ depending on the car model.

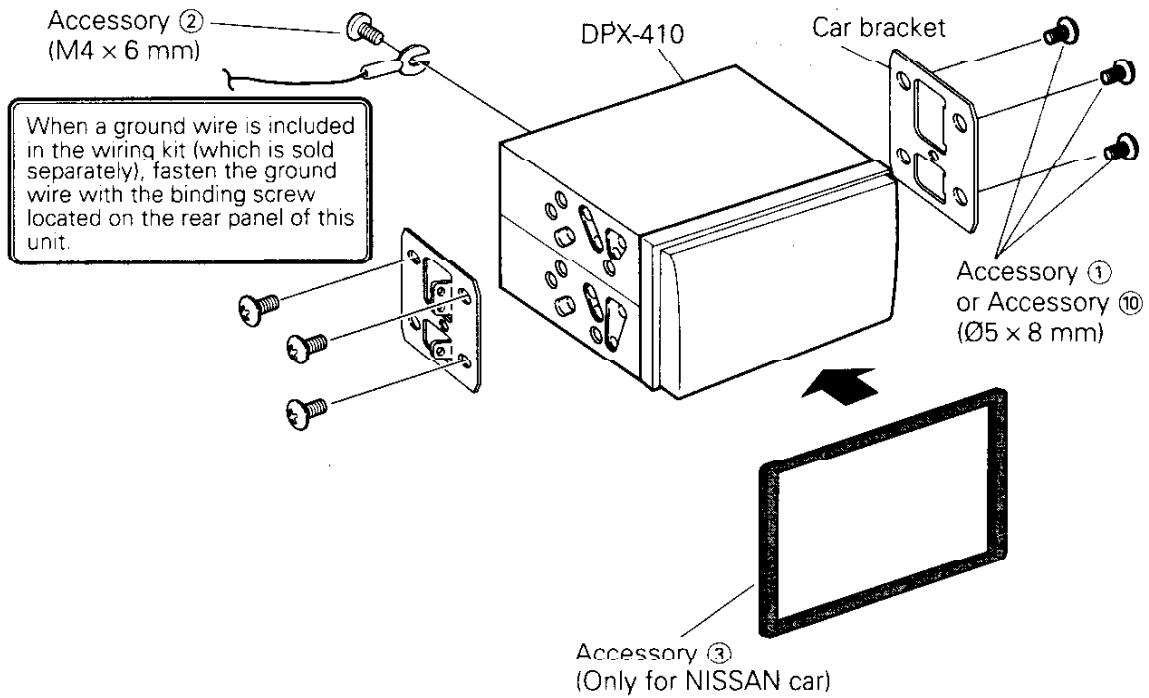

▲ CAUTION

Install such that the installation angle of this unit is 30 [deg] or less. The sound skipping may result if installed at an angle greater than 30 [deg].

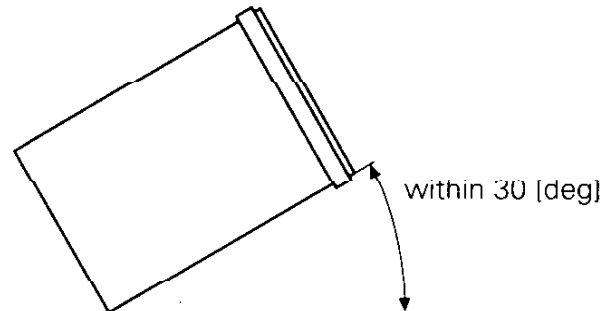

INSTALLATIONS (for HONDA ACURA)

The assembly and installation method will differ depending on the car model. Please perform the jobs in the following order.

Car model name	Step 1	Step 2
ACCORD	Assembly 1	Installation 2
LEGEND	Assembly 1	Installation 3
CR-V	Assembly 2	Installation 4
Other HONDA Cars	Assembly 1	Installation 1

■ Assembly 1

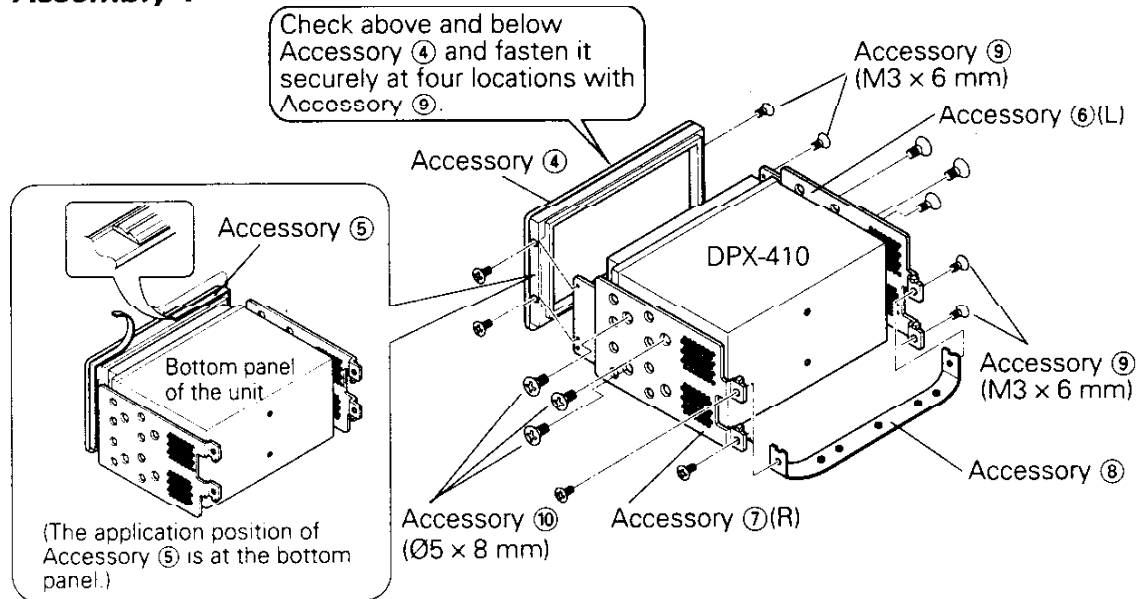

■ Assembly 2

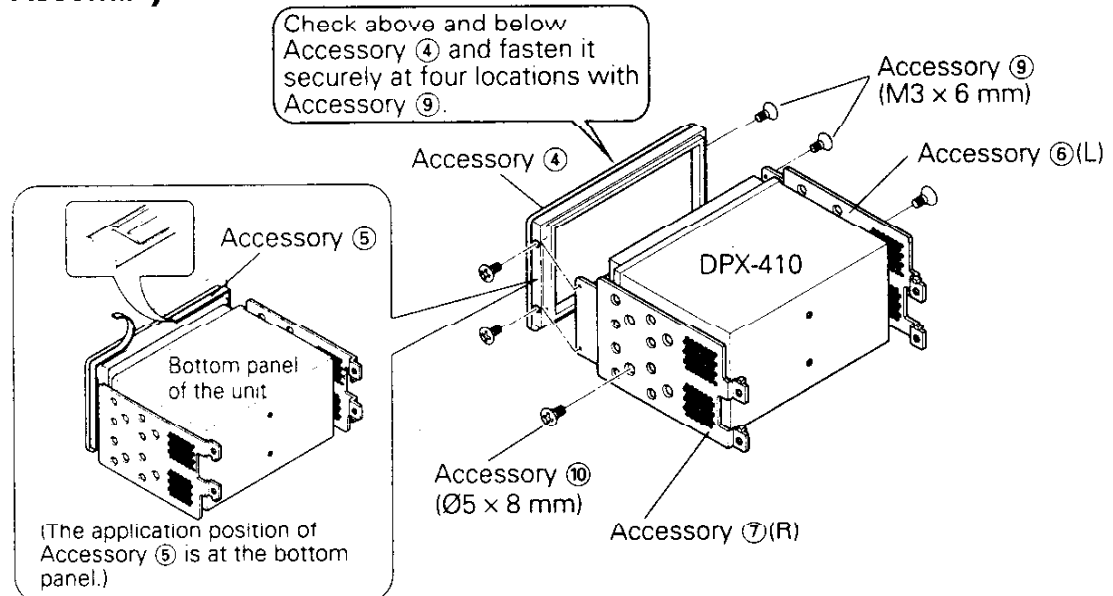

■ Installation 1

Remove the factory-installed car stereo and install the unit that was assembled in Assembly 1.

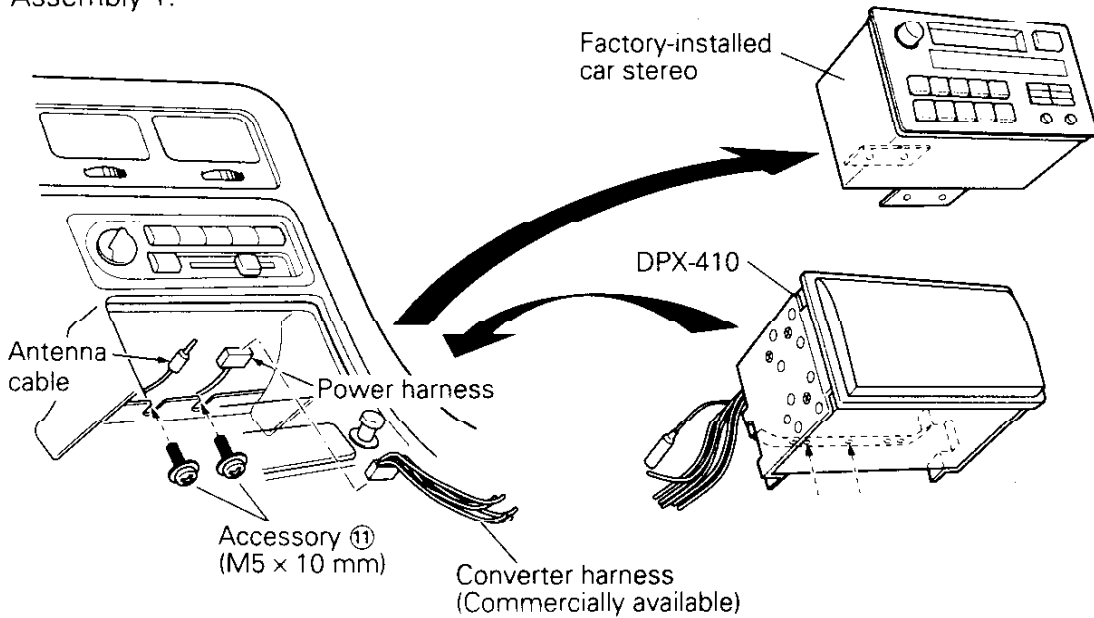

■ Installation 2 (for ACCORD)

1. Attach Accessory ⑫ to Accessory ⑧ which was assembled in Assembly 1
2. Remove the factory-installed car stereo and install the unit.

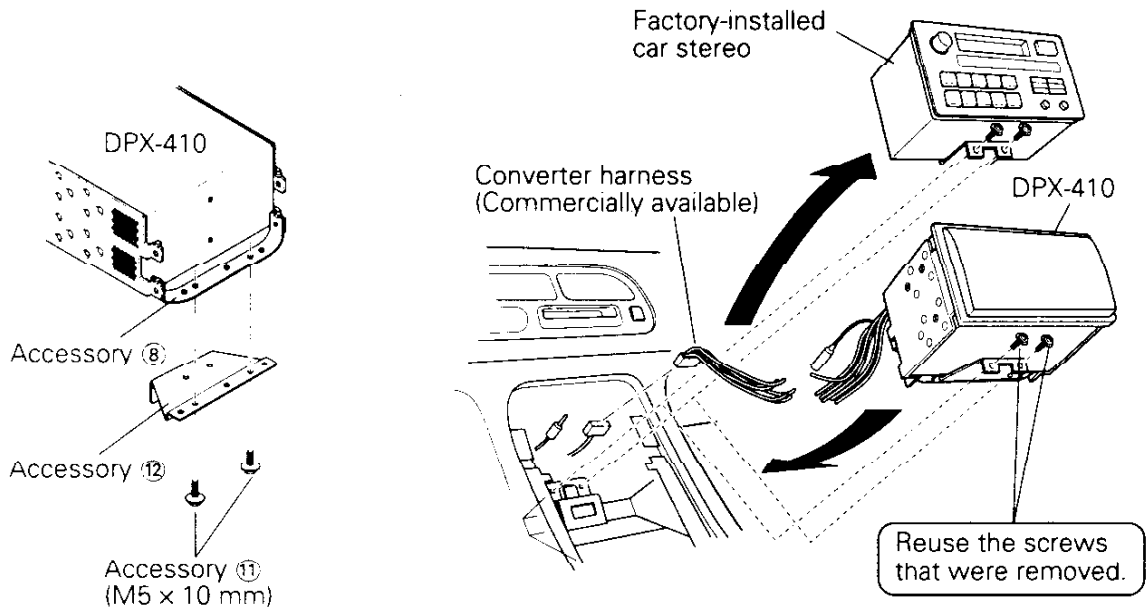

INSTALLATIONS (for HONDA ACURA Car)

■ Installation 3 (for LEGEND)

1. Attach Accessory ⑬ to Accessory ⑧ which was assembled in Assembly 1.

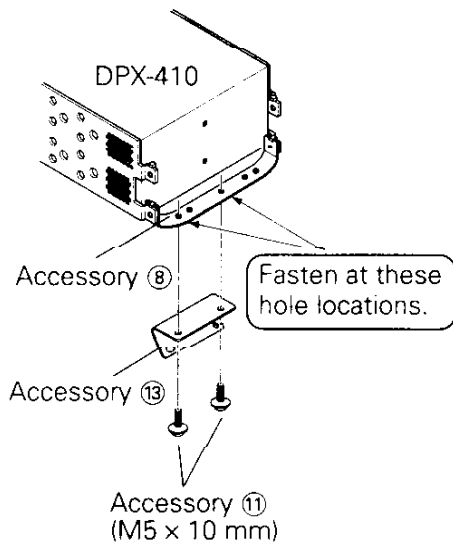

2. Remove the factory-installed car stereo and install the unit.

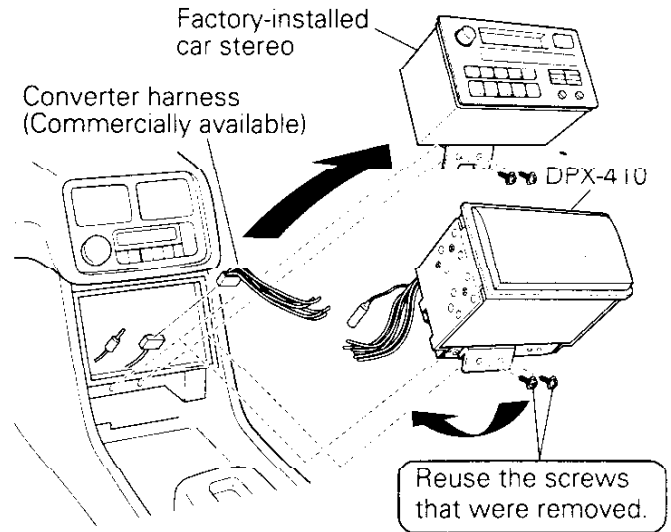

■ Installation 4 (for CR-V)

1. Use Accessory ⑭ to mount the car bracket to the center panel which was removed.

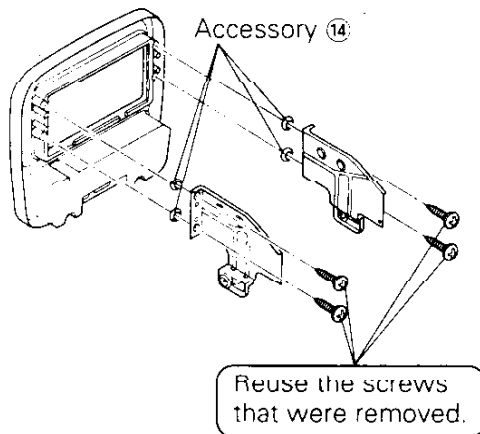

2. Use Accessory ① to attach the unit which was assembled in Assembly 2.

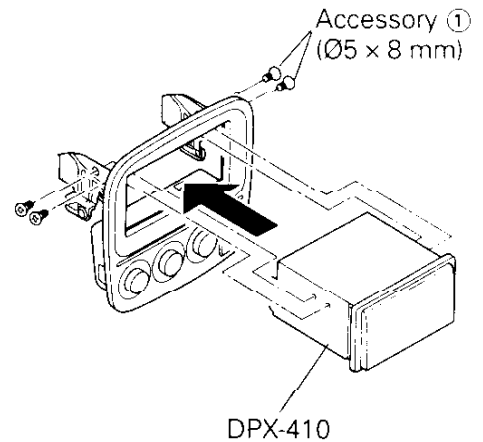

3. Install the center panel with the unit in your car.

TROUBLESHOOTING GUIDE

Sometimes you may think the system is broken due to a simple misoperation or incorrect wiring. Check the items listed below before requesting repairs.

Symptom	Cause	Remedy
Power will not come on.	<ul style="list-style-type: none"> • The fuse is blown. • Output-input power wires have been connected incorrectly. 	<ul style="list-style-type: none"> • Check that the wires have not shorted, and then replace the fuse with one of the specified rating. • See "CONNECTIONS (P.42)" and make connections properly.
No sound, or sound level is low.	<ul style="list-style-type: none"> • The attenuator is on. • The volume is turned all the way down. • Fader and balance are set all the way to one side. • Speaker wires are connected incorrectly. • There is condensation on the CD. 	<ul style="list-style-type: none"> • Turn the attenuator off. • Increase the volume. • Adjust fader and balance. • See "CONNECTIONS (P.42)" and connect correctly. • Set the CD aside and try again later. (P.6)
Operations are not performed even when operation switches are pressed.	The microcomputer is malfunctioning.	Press the reset button.
Tape cannot be load.	<ul style="list-style-type: none"> • Cassette casing is deformed. • Tape is backwards. • A cassette tape is already loaded. 	<ul style="list-style-type: none"> • Try using another cassette tape. • Try loading the cassette tape with the tape side facing right. • Eject the cassette tape already loaded and try again.
Tuner sensitivity is poor.	<ul style="list-style-type: none"> • The automatic car antenna is not extended. • Automatic power antenna control wire is not connected. 	<ul style="list-style-type: none"> • Extend the antenna further. • See "CONNECTIONS (P.42)" and connect the antenna control wire.
CD cannot be inserted.	A CD is already inserted.	Eject the CD already inserted and try again.
CD is ejected soon after inserting.	<ul style="list-style-type: none"> • The CD is upside down. • The CD is extremely dirty. • There is condensation on the CD. 	<ul style="list-style-type: none"> • Insert the CD with the label side facing up. • See "Cleaning your CDs (P.7)" and try cleaning the CD. • Set the CD aside and try again later. (P.6)

Symptom	Cause	Remedy
Sound skips.	<ul style="list-style-type: none"> • The installation angle exceeds 30(deg). • The installation is not stable. • The CD is scratched or dirty. 	<ul style="list-style-type: none"> • Adjust the angle to within 30(deg). • Tighten all screws. • If skipping occurs at the same location even when the car is stopped, the problem is with the CD. See "Cleaning CDs (P.7)" and try cleaning the CD.
Sound quality is poor. (Noise occurs during playback.)	<ul style="list-style-type: none"> • The sound quality of this particular CD is poor. • The CD is scratched or dirty. 	<ul style="list-style-type: none"> • If there is no problem when playing other CDs, then the problem is with this CD. • See "Cleaning CDs (P.7)" and try cleaning the CD.
Cannot get to the desired track even through track selection.	The unit is in track random play mode.	Cancel track random play mode.
Sound quality is poor. (sound is distorted.)	<ul style="list-style-type: none"> • Volume is too loud. • Heads are dirty. • The speaker wire is being pinched by screw on the car. • Speakers have been wired incorrectly. • The high temperature in the car has caused the internal temperature of the unit to exceed 60 °C and this has activated the protection circuit. 	<ul style="list-style-type: none"> • Use an appropriate volume level. • See "Cleaning the tape head (P.6)" and clean the heads. • Check all speaker wiring. • Connect all speaker output terminals to the correct speaker terminals. • Lower the volume and wait a while until the temperature in the car has dropped. The unit will return to a normal operating condition when the internal temperature of the unit drops.
Contents of memory are lost when the engine key is turned off.	Battery power is not connected to the prescribed location.	See "CONNECTIONS (P.42)" and connect correctly.
SRS effects are not obtained.	<ul style="list-style-type: none"> • Front speaker is not connected. • The front output and the rear output are connected in reverse. • The ⊕ and ⊖ speaker terminals are connected in reverse. • Fader and balance are set all the way to one side. 	<ul style="list-style-type: none"> • Connect the front speaker. • See "CONNECTIONS (P.42)" and connect correctly. • See "CONNECTIONS (P.42)" and connect correctly. • Adjust fader and balance.

TROUBLESHOOTING GUIDE

● When a disc changer (sold separately) is connected

Symptom	Cause	Remedy
System will not enter disc changer mode.	Changer input of this unit is not connected.	Connect the changer input of this unit.
Operations are not performed even when operation switches are pressed.	The microcomputer is malfunctioning.	Press the reset button.
The specified disc does not playback.	<ul style="list-style-type: none"> • The disc is extremely dirty. • The disc is upside down. • There are two discs inserted in the same location. • The specified number differs from the location the disc has been inserted. • There is a large scratch on the disc. 	<ul style="list-style-type: none"> • Try cleaning the disc (P.7). • Eject the magazine and insert discs again properly. • Eject the magazine and insert discs again properly. • Eject the magazine and check the number of the specified disc. • Use another disc.
The changer display appears but there is no sound.	<ul style="list-style-type: none"> • The volume is turned all the way down. • The attenuator is on. • The microcomputer is malfunctioning. 	<ul style="list-style-type: none"> • Increase the volume. • Turn the attenuator off. • Press the reset button.
Cannot get to the desired track even through track selection.	The unit is in track random play or magazine random play mode.	Cancel track random play or magazine random play mode.

● **The following displays are used to indicate the status of the DPX-410.**

EJECT : No disc magazine is loaded. No disc magazine is present at all. Etc.

NO DISC : Not even one disc loaded in the disc magazine.

NO CHANGER : No disc changer is connected to the CH1 or CH2 terminal of the KCA-S200.

ERROR 04 : Disc is extremely dirty. Disc is upside down. Disc is badly scratched. No disc is loaded in the magazine. No tray is loaded in the magazine.

ERROR 77/ Not functioning normally for some reason.

ERROR 99 : ⇨ Please press the reset button on the unit. If the "ERROR 77" or "ERROR 99" display does not disappear, please contact your Kenwood dealer.

HOLD : If the temperature exceeds 60[deg]C, a protective circuit will activate, and all operations will stop. This is the display when this occurs.

⇨ This display will eventually disappear once the temperature of the location in which the disc changer is installed goes down.

H-HOLD : Internal temperature of the CD player exceeding 60[deg]C activates the protection circuit, disabling the operation. This results in this display.

⇨ Lower the ambient temperature at the installed location and leave it for a while.

NO NAME :

- An attempt was made to display the name of the station being received but it was not set in memory.
- An attempt was made to display the name of the disc being played but it was not set in memory.
- An attempt was made to display the track/disc title of the MD disc during play, but the MD has no titles.
- An attempt was made to display the station name/disc name after the battery had been removed for a long period.

NO TRACK : No data is recorded on the MD for which playback was attempted.
⇨ The next MD is played automatically.

BLANK DISC : Nothing is recorded on the MD for which playback was attempted.
⇨ The next MD is played automatically.

SPECIFICATIONS

These specifications and designs are subject to change without notice to reflect technological development.

FM tuner section

Frequency range (200 kHz Space)	87.9 MHz – 107.9 MHz
Usable sensitivity (S/N = 30dB)	9.3 dBf (0.8 μ V/75 ohms)
Quieting Sensitivity	15.2 dBf (1.6 μ V/75 ohms)
Frequency response (\pm 3.0 dB)	30 Hz – 15 kHz
Signal to Noise ratio (MONO)	75 dB
Selectivity(\pm 400 kHz)	\geq 80 dB
Stereo separation (1 kHz)	40 dB

AM tuner section

Frequency range (10 kHz space)	530 kHz – 1700 kHz
Usable sensitivity	28 dB μ (25 μ V)

Cassette player section

Tape speed	4.76 cm/sec.
Wow & Flutter (WRMS)	0.08 %
Frequency response (\pm 3.0 dB)	25 Hz – 22 kHz (70 μ s)
Separation(1 kHz)	40 dB
Signal to Noise ratio (Dolby NR OFF)	57 dB
Signal to Noise ratio (Dolby B NR ON)	65 dB

CD player section

Laser diode	GaAlAs (λ =780 nm)
Digital filter (D/A)	8 Times Over Sampling
D/A Converter	1 Bit
Spindle speed	500 – 200 rpm (CLV)
Wow/Flutter	Below measurable limit
Frequency response (\pm 1dB)	10 – 20 kHz
T.H.D. (1KHz)	0.01%
Signal to Noise ratio	93 dB
Dynamic range	93 dB
Stereo separation	85 dB

Audio section

Maximum output power	35 W × 4
Full bandwidth power	20 W × 4 (4 ohms, 30 Hz – 20 kHz, 1% THD)
Preout level / load	1200 mV/10 k ohms
Impedance	≤ 600 ohms
Tone action (Bass)	100 Hz ± 10 dB
(Treble)	10 kHz ± 10 dB

General

Operating voltage	14.4 V (11 – 16 V allowable)
Current consumption	10 A at Rated power
Installation size (W × H × D)	178 × 100 × 155 mm (7 × 3 – 15/16 × 6 – 1/8 inch)
Weight	2.7 kg (5.95 lbs)

Accessories

Remote control	1 unit
Power harness	1 pc.
Accessory set for installation	1 set

KENWOOD